

Owner's Manual
for Vehicle



745i 745Li

Congratulations, and thank you for choosing a BMW.

Thorough familiarity with your vehicle will provide you with enhanced control and security when you drive it. We therefore have this request:

Please take the time to read this Owner's Manual and familiarize yourself with the information that we have compiled for you before starting off in your new vehicle. It contains important data and instructions intended to assist you in gaining maximum use and satisfaction from your BMW's unique range of technical features. The manual also contains information on maintenance designed to enhance operating safety and contribute to maintaining the value of your BMW throughout an extended service life.

This Owner's Manual should be considered a permanent part of this vehicle. It should stay with the vehicle when sold to provide the next owner with important operating, safety and maintenance information.

This manual is supplemented by a Service and Warranty Information Booklet for US models or a Warranty and Service Guide Booklet for Canadian models.

We recommend that you read this publication thoroughly.

Your BMW is covered by the following warranties:

- New Vehicle Limited Warranty
- Limited Rust Perforation Warranty
- Federal Emissions System Defect Warranty
- Federal Emissions Performance Warranty
- California Emission Control System Limited Warranty

Detailed information about these warranties is listed in the Service and Warranty Information Booklet for US models or in the Warranty and Service Guide Booklet for Canadian models.

We wish you an enjoyable driving experience.

BMW AG

Contents

Notes

- 6 Using this Owner's Manual
- 6 Symbols used
- 7 The individual vehicle
- 7 Editorial notice
- 8 For you own safety
- 9 REPORTING SAFETY DEFECTS

Cockpit

- 12 Driver's side – Controls and displays
- 16 Comfort and convenience – Controls and displays
- 18 Buttons in steering wheel

Control Center

- 19 The concept
- 19 Controller
- 19 Control Display
- 20 Symbols and lists
- 22 Menus in Control Display
- 23 Assistance window

Voice command

- 25 Voice command system
- 25 Voice commands
- 27 Notices
- 27 The notebook
- 29 Brief commands

Opening and closing

- 34 Keys
- 35 Central locking system
- 35 Opening and closing – from outside
- 37 Opening and closing – from inside
- 38 Doors
- 38 Luggage compartment lid

- 40 Luggage compartment
- 40 Alarm system
- 42 Electric power windows
- 43 Sliding/tilt sunroof

Adjustments

- 45 Correct sitting position
- 45 Seats
- 48 Head restraints
- 50 Safety belts
- 50 Heated seats
- 51 Active seat ventilation
- 52 Active seat
- 52 Mirror
- 53 Steering wheel adjustment
- 54 Seat, mirror and steering wheel memory
- 55 Airbags
- 57 Transporting children safely
- 58 LATCH child-restraint system
- 59 Child-safety locks
- 59 Car Memory, Key Memory

Driving

- 61 Ignition lock
- 62 Starting the engine
- 62 Switching off engine
- 62 Parking brake
- 66 Automatic transmission with L mode
- 69 Automatic transmission with Steptronic
- 71 Turn signal indicators/headlamp flasher
- 71 Wiper system
- 73 Washer fluid

73 Programmable cruise control

Everything under control

77 Odometer, outside temperature display, clock

77 Tachometer

78 Service Interval Display

80 Check Control

81 Computer

86 Changing settings

Technology for comfort, convenience and safety

88 PDC Park Distance Control

89 Driving stability control/
DSC Dynamic Stability Control

91 Driving stability control/ABS Antilock
Brake System

91 Dynamic Drive

92 EDC Electronic Damping Control

92 RDC Tire Pressure Monitor

94 Self-leveling suspension

94 Adaptive brake lamp

Lamps

96 Parking lamps/low beams

97 Instrument lighting

97 High beams/standing lamps

97 Front fog lamps

97 Interior lamps

A congenial climate

99 Automatic climate control

105 Rear air conditioner

106 Parked-car ventilation system

Practical interior accessories

108 Universal Garage Door Opener

109 Sun blinds

110 Rear cooler

110 Glove compartment

111 Storage compartments

112 Beverage holders

112 Ashtray, front

113 Cigarette lighter, front

113 Power socket

113 Ashtray, rear

113 Cigarette lighter, rear

113 Center armrest

114 Ski bag

Things to remember when driving

118 Break-in procedures

118 General driving notes

119 Brake system

120 Cargo loading

120 Roof-mounted luggage rack

Navigation

124 Safety

124 GPS

124 Map CD

125 Starting the navigation system

125 Display in assistance window

126 Selection options

126 Destination entry

126 Manual entry of destination address

128 Select the town or city and the street
from the directory

128 Map-guided destination selection

129 Selecting destination in Information

129 Selecting interesting destinations

130 Recent destinations

130 Destination list

130 Route selection

131 Starting the destination guidance
system

132 Displaying route

133 Select new route

133 Voice messages

134 Terminate/interrupt active guidance

134 Creating a directory

135 Location

136 Wordmatch principle

136 What to do if ...

Sound system

140 Controls

140 Care instructions

140 To switch on/off

140 Using with ignition off

141 Volume adjustment

141 Tone control

Radio

- 143 Select the frequency band
- 143 Station selection
- 144 Storing and retrieving a station
- 145 Weather Band

CD Compact Disc

- 146 Using the buttons to search for music tracks
- 147 Searching for music tracks in the Control Display

CD changer

- 149 Starting and stopping the CD changer
- 149 Status displays
- 149 Searching for music tracks in the Control Display
- 150 Using the buttons to search for music tracks

MiniDisc MD

- 151 Using the buttons to search for music tracks
- 152 Searching for music tracks in the Control Display

Cassette

- 153 Noise suppression
- 154 Music track search

Using your mobile phone

- 158 Safety notice
- 159 Care instructions
- 159 Operation
- 161 Hands-free system
- 161 To make SOS call
- 161 Initial operation
- 162 Getting started
- 162 Telephone directory
- 163 To select a number from the Top 8 list
- 164 Redialing, including numbers not initially reached
- 164 Missed calls

Refueling

- 168 Fuel filler door
- 169 Fuel specifications

Wheels and tires

- 170 Tire inflation pressure
- 171 Tire condition
- 172 Tire replacement
- 173 Wheel and tire combinations
- 173 Special characteristics of winter tires
- 173 Snow chains

Under the hood

- 175 Hood
- 176 Engine compartment
- 176 Engine oil
- 177 Coolant
- 178 Brake fluid

Maintenance

- 179 The BMW Maintenance System
- 179 Care

Rules and regulations

- 180 California Proposition 65 Warning
- 180 OBD connector

Replacing components

- 181 Onboard tool kit
- 181 Windshield wiper blades
- 181 Lamps and bulbs
- 183 Changing a tire
- 185 Battery
- 186 Fuses

Help – Giving and receiving

- 187 Warning triangle
- 187 First-aid kit
- 187 Jump-starting
- 188 Towing

Technical data

- 192 Engine specifications
- 193 Dimensions
- 194 Weights
- 194 Capacities

Everything from A to Z

- 195 Contents

Notes

Using this Owner's Manual

In compiling this Owner's Manual we have made every effort to furnish you with a convenient reference source affording quick access to all the essentials. The fastest way to find detailed information on any specific subject is to turn to the comprehensive index at the back of the manual. For a brief initial overview, please refer to the first chapter.

Should the day come when you decide to sell your BMW, please remember to make certain that the new owner receives this manual; it is an important part of the vehicle.

If you have any additional questions, your BMW center will be glad to advise you.

Symbols used



Indicates precautions that must be followed precisely in order to avoid the possibility of personal injury and serious damage to the vehicle. ◀

◀ Marks the end of a specific item of information.



Contains information that will assist you in gaining the optimum benefit from your vehicle and enable you to care more effectively for your vehicle. ◀



Refers to measures that can be taken to help protect the environment. ◀

* Identifies special equipment, county-specific equipment and optional extras.

"..." Identifies Control Display texts used to select individual functions. ◀



These sections contain information on using the voice command system. ◀

>>...<< Verbal instructions to use with the voice command system. It is not necessary to say the words in parentheses.

>...< Identifies the answers generated by the voice command system. ◀



Identifies systems or components, which can either be activated or adapted to suit an individual driver's requirements ("Car Memory", "Key Memory"). Refer to page 59.

Remember that activation and adjustments on some of these systems can only be performed at your BMW center. ◀

Symbols on vehicle components



Indicates that you should consult the relevant section of this Owner's Manual for information on a particular part or assembly.

The individual vehicle

On purchasing your BMW, you have decided in favor of a model with individualized equipment and features. This Owner's Manual describes the entire array of options and equipment available with a specific BMW model.

Please bear in mind that the manual may contain information on accessories and equipment that you have not specified for your own vehicle. Sections describing options and special equipment are marked by asterisks * to assist you in identifying possible differences between the descriptions in this manual and your own vehicle's equipment.

Should your BMW be equipped with features or accessories not described in this manual, please consult the enclosed supplementary manual(s).

Editorial notice

BMW pursues a policy of continuous, ongoing development that is conceived to ensure that our vehicles continue to embody the highest quality and safety standards combined with advanced, state-of-the-art technology. For this reason, it is possible that the features described in this Owner's Manual could differ from those on your vehicle. Nor can errors and omissions be entirely ruled out. You are therefore asked to appreciate that no legal claims can be entertained on the basis of the data, illustrations or descriptions in this Owner's Manual.

For you own safety

 Use unleaded gasoline only. Fuels containing up to and including 10% ethanol or other oxygenates with up to 2.8% oxygen by weight – that is, 15% MTBE or 3% methanol plus an equivalent amount of co-solvent – will not void the applicable warranties respecting defects in materials or workmanship. Field experience has indicated significant differences in fuel quality – volatility, composition, additives, etc. – among gasolines offered for sale in the United States and Canada. The use of poor quality fuels may result in driveability, starting and stalling problems especially under certain environmental conditions such as high ambient temperature and high altitude.

Should you encounter driveability problems which you suspect could be related to the fuel you are using, we recommend that you respond by switching to a recognized high-quality brand.

Failure to comply with these recommendations may result in unscheduled maintenance.

Follow the relevant safety rules when you are handling gasoline. ◀

Important safety information

 For your own safety, use genuine parts and accessories approved by BMW.

When you purchase accessories tested and approved by BMW and Original BMW Parts, you simultaneously acquire the assurance that they have been thoroughly tested by BMW to ensure optimum performance when installed on your vehicle.

BMW warrants these parts to be free from defects in material and workmanship.

BMW will not accept any liability for damage resulting from installation of parts and accessories not approved by BMW.

BMW cannot test every product made by other manufacturers to verify if it can be used on a BMW safely and without risk to either the vehicle, its operation, or its occupants. Original BMW Parts, BMW Accessories and other products approved by BMW, together with professional advice on using these items, are available from all BMW centers.

Installation and operation of non-BMW approved accessories such as alarms, radios, amplifiers, radar detectors, wheels, suspension components, brake dust shields, telephones – including operation of any portable cellular phone from within the vehicle without using an externally mounted antenna – or transceiver equipment, for instance, CBs, walkie-talkie, ham radio or similar accessories, may cause extensive damage to the vehicle, compromise its safety, interfere with the vehicle's electrical system or affect the validity of the BMW Limited Warranty. See your BMW center for additional information. ◀

 Maintenance, replacement, or repair of the emission control devices and systems may be performed by any automotive repair establishment or individual using any certified automotive part. ◀

The following only applies to vehicles owned and operated in the US.

REPORTING SAFETY DEFECTS

If you believe that your vehicle has a defect which could cause a crash or could cause injury or death, you should immediately inform the National Highway Traffic Safety Administration (NHTSA) in addition to notifying BMW of North America, LLC, P.O. Box 1227, Westwood, New Jersey 07675-1227, Telephone (201) 307-4000.

If NHTSA receives similar complaints, it may open an investigation, and if it finds that a safety defect exists in a group of vehicles, it may order a recall and remedy campaign. However, NHTSA cannot become involved in individual problems between you, your dealer, or BMW of North America, LLC.

To contact NHTSA, you may either call the Auto Safety Hotline toll-free at 1-800-424-9393 (or 366-0123 in Washington, D.C. area) or write to: NHTSA, U.S. Department of Transportation, Washington, D.C. 20590. You can also obtain other information about engine vehicle safety from the Hotline.



The background of the page is a blurred, front-facing view of a dark blue car. The car's headlights, grille, and hood are visible, though out of focus. A white rectangular text box is positioned on the right side of the image, containing the title and two paragraphs of text.

At a glance

This overview of buttons, switches and displays is intended to serve as a source of orientation in your vehicle's operating environment.

The section will also assist you in becoming acquainted with the control concepts and options available for operating the various systems.

Cockpit

Driver's side – Controls and displays

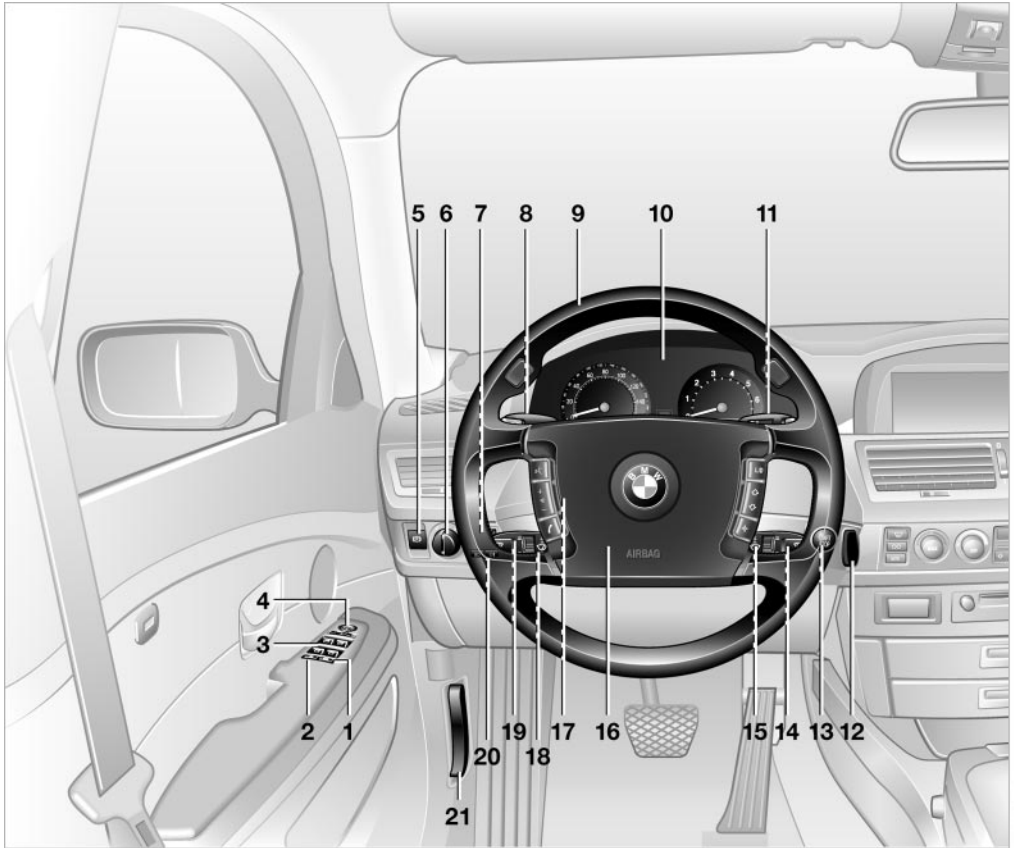

MW01208UEA

- 1 Rear window sun blind 109
- 2 Rear window safety switch 42
- 3 Electric power windows 42
- 4 Exterior mirrors 52
- 5 Parking brake 62
- 6 Parking lamps and low beams 96
- 7



Instrument lighting 97

8



Turn signal indicators 71



High beams, headlamp flasher 97



Computer 81,
Check Control 80



Computer 81



Standing lamps 97

- 9 Steering wheel 18
- 10 Info Display 14
- 11 Automatic transmission lever 66
- 12 Ignition lock 61
- 13



Switching ignition on and off,
starting the engine 62

14



Windshield wipers 71



Rain sensor 71

15



Park Distance Control (PDC) 88

16 Horn: the entire surface

17



Steering wheel heating 53



Steering wheel adjustment 53

18



Unlocking the luggage
compartment 39

19



Programmable cruise control 73

20 Front fog lamps 97



Front fog lamps

21 Opening the hood 175

Info Display

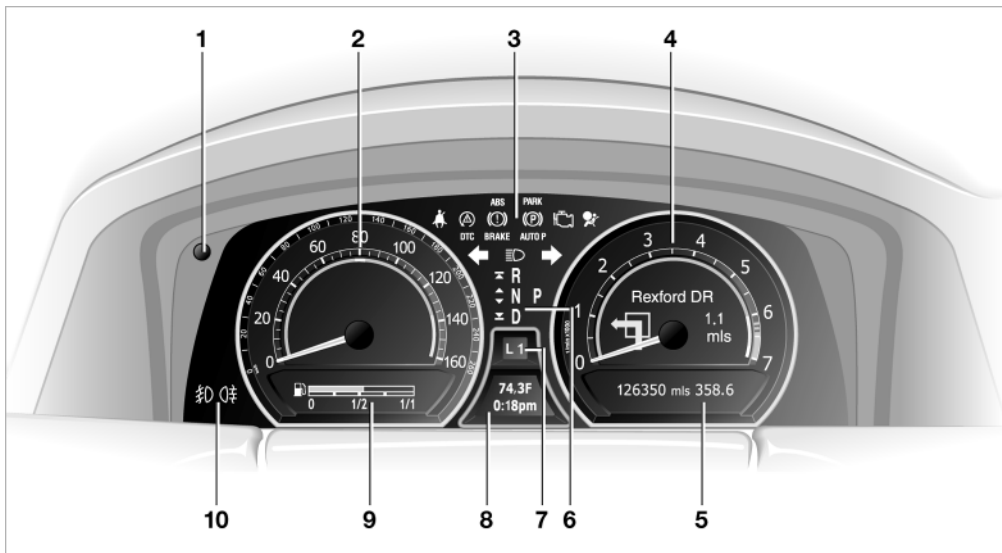

MV01294DEA

- 1 To view odometer display and reset trip odometer to zero [77](#)
- 2 Speedometer with:
 - ▷ Display for programmable cruise control [73](#)
 - ▷ Speed limit display [84](#)
- 3 Indicator and warning lamps [15](#)
- 4 Tachometer [77](#)
with navigation system guidance display [132](#)
- 5 Display panel for
 - ▷ Computer [81](#)
 - or
 - ▷ Check Control text messages [80](#)
 - or
 - ▷ Voice command system [26](#)
- 6 Transmission range selection [66](#)
- 7 Display panel for
 - ▷ Automatic transmission program display [66](#)
- 8 Indicator for
 - ▷ Outside temperature [77](#)
 - ▷ Clock [86](#)
 - or
 - ▷ Indicator and warning lamps [80](#)
- 9 Fuel gauge and computer [81](#)
- 10 Fog lamps [97](#)

Indicator and warning lamps

Technology that monitors itself

The indicator and warning lamps identified by the ● symbol are subjected to an operation check each time you switch on the ignition or start the engine. They each light up once for different periods of time.

When a malfunction occurs in a monitored system, the corresponding lamp will either fail to go out when the engine is started, or it will come on again during normal driving. For information on how you should respond when this happens, please refer to the pages indicated.



Please fasten safety belts ● 50



DSC Dynamic Stability Control ● 89



DTC Dynamic Traction Control 89



ABS Antilock Braking System ● 91



Parking brake/Brake system hydraulic circuits/DBC Dynamic Brake Control ● 62/ 91/ 178



Parking brake/Brake hydraulic systems/DBC Dynamic Brake Control for Canadian models.



Parking brake 62, 65



Parking brake 62, 65



Automatic parking brake – Automatic Hold ● 63, 65



Engine ● 180



Airbags ● 56



Turn signal indicators 71



High beams/headlamp flasher 97



Front fog lamps 97

Colors

The indicator and warning lamps can light up in different colors and combinations. The following section explains the significance of the individual colors as well as how you should respond when they appear.

▷ Red:

Stop the vehicle immediately or

an important reminder

▷ Red and yellow:

To drive; drive cautiously

▷ Yellow:

Have the system inspected at the earliest opportunity or

for your information

▷ Green

For your information

▷ Blue:

For your information.

Comfort and convenience – Controls and displays

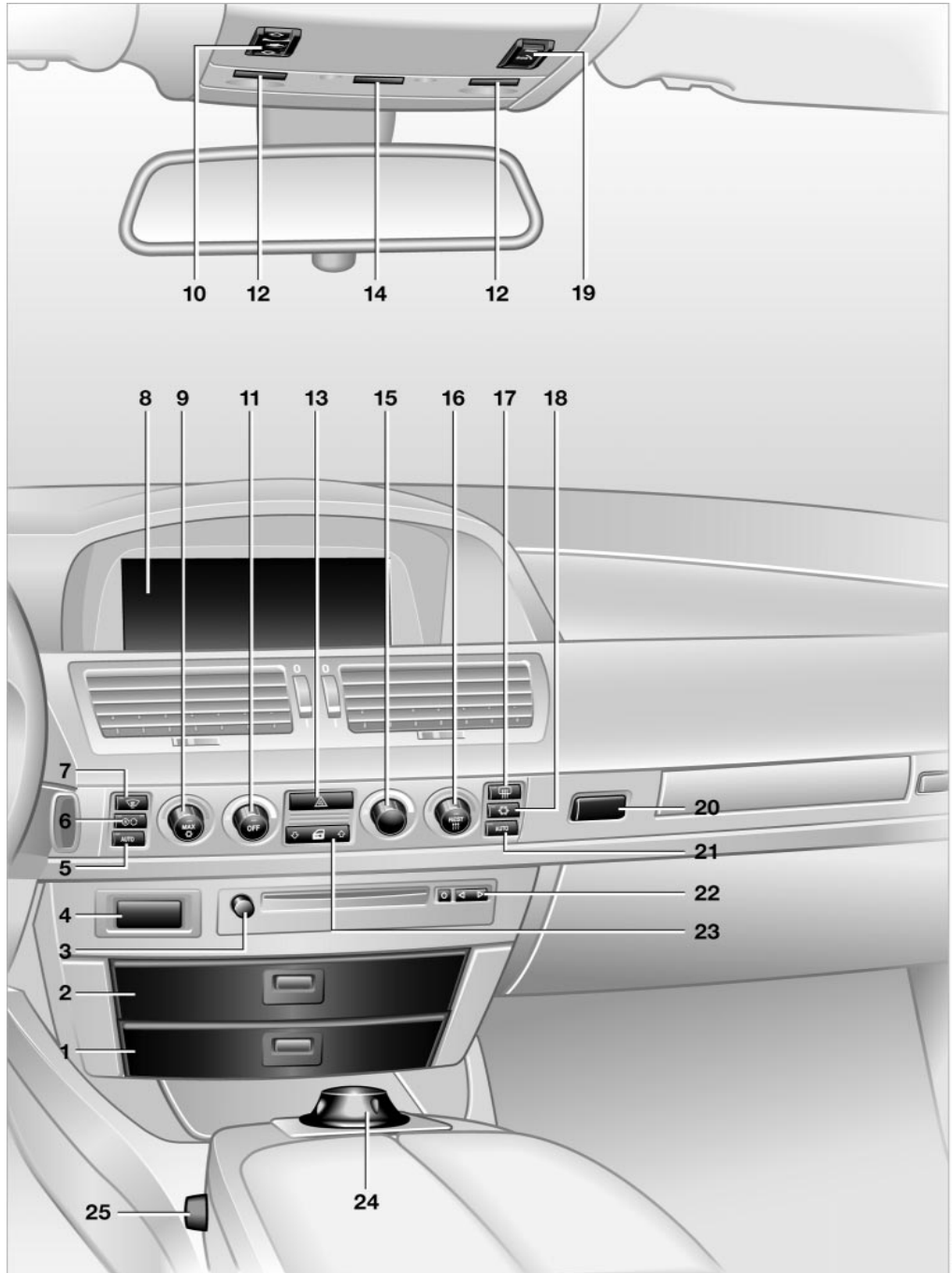

MM0121CMA

- 1 Glasses compartment [111](#)
- 2 Storage compartment [112](#)
- 3 Radio on/off switch and volume adjustment [140](#), [141](#)
- 4 Key Pad [160](#)
- 5 Automatic air distribution and air supply – left side of interior [100](#)
- 6 Outside air/AUC Automatic recirculated-air control/Recirculated air [101](#)
- 7 To defrost windshield and windows [101](#)
- 8 Control Display [19](#)
- 9 Temperature on left-hand side of passenger compartment – turn and maximum cooling – press [101](#), [101](#)
- 10 Sliding/tilt sunroof [43](#)
- 11 Air supply on left-hand side of passenger compartment – turn and switch off automatic climate control – press [101](#), [103](#)
- 12 Reading lamps [98](#)
- 13 Hazard warning flashers
- 14 Interior lamps [97](#)
- 15 Air supply on right-hand side of passenger compartment [100](#)

- 16 Temperature on right-hand side of passenger compartment – turn and residual heat mode – press [101](#), [101](#)
- 17 Rear window defroster
- 18 Air conditioning [101](#)
- 19 Trigger emergency SOS call [161](#)
- 20 Open the glove compartment
- 21 Automatic air distribution and air supply, right-hand side of passenger compartment [103](#)
- 22 Station/title search and CD, MD [140](#)
- 23 Central locking system [37](#)
- 24 Controller [19](#)
- 25 Seat adjustment [45](#)



Seat heaters [50](#)



Active seat ventilation [51](#)



BMW active seat [52](#)



Seat, mirror and steering wheel memory [54](#)

Buttons in steering wheel

Buttons are integrated within the steering wheel to allow convenient control of the following systems, with minimal driver distraction from road and traffic conditions:

- ▷ The automatic transmission's L mode
- ▷ Selected radio functions
- ▷ Selected mobile phone functions
- ▷ The voice command system.

 The buttons in the steering wheel are only operational when the corresponding systems are switched on. ◀



Cellular phone:

Receive an incoming call, initiate dialing and end a call



Volume



Voice command system:

To switch on and off



Fast forward/reverse:

- ▷ Radio

Press briefly: scans for stations in FM band
Extended pressure: Search

- ▷ CD/MD

Press briefly: jump to next track
Extended pressure: fast forward within track

- ▷ Cassette deck

Press briefly: stop track skip or fast forward
Extended pressure: fast forward



Available for individual programming:
You can program the function for this button by selecting "MFL" in the "Settings" menu, refer to page [53](#).



L/D

L mode:

Press briefly to alternate between the automatic program and the L mode, refer to page [68](#).



S/D/M

Steptronic – Canadian models only:

Press briefly to proceed through a selection sequence consisting of the automatic program, the Sport program and the manual mode, refer to page [69](#).

Control Center

The concept

The Control Center has been designed to avoid the unnecessary complexity created by an extended number of switches and controls. It consists of the controller and the Control Display.

The controller is used to select the functions that will appear in the Control Display. In addition, the Control Display also shows you Check Control messages.

Controller



You can slide, turn and press the controller to enter commands. You can use it for all of the functions in the Control Display.

⚠ To avoid posing an unnecessary hazard, both to your own vehicle's occupants and to other road users: never attempt to use the controls or make adjustments unless traffic and road conditions allow. ◀

The following introduction illustrates how easy it is to use the Control Center.

You can find detailed instructions describing how to use the individual systems in the separate sections.

Control Display

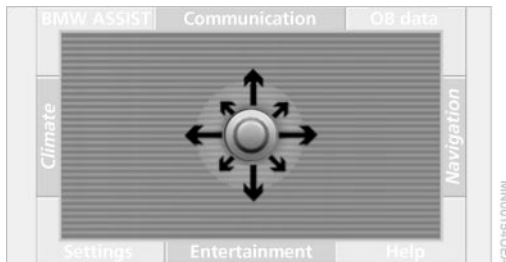

An orientation menu is available for selection. Slide the controller

- ▷ toward the currently active menu
- ▷ twice in one direction.

Select menu



Slide the controller to select a menu - here: "Settings."

The menu appears on the screen as soon as you release the controller.



You can move directly to a different menu by sliding the controller. ◀

Selecting menu entries

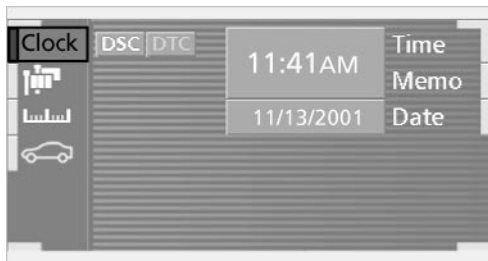

Turn the controller to select the menu entry, here: "Clock."

Among the available menu entries:

- ▷ Adjustment options
- ▷ Program
- ▷ Function

Confirm selection or entry

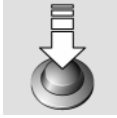

Press the controller to confirm the selection, here: "Clock."

Select the desired setting for adjustment from the menu entry, here: "Time" and confirm your entry

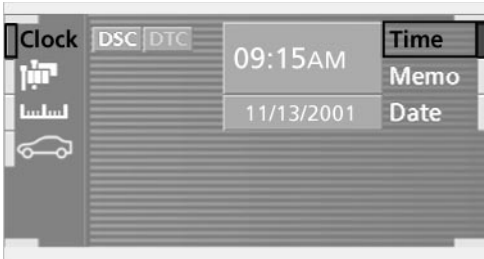

Settings

The first setting option for time is activated.



- ▷ Turn the controller to select your setting
- ▷ Press the controller to confirm the new setting – store – and to proceed to the next highlighted position to set.

Changing menu page

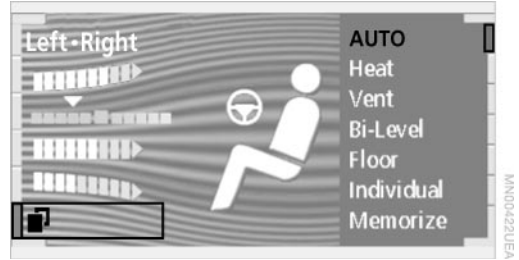

You can select individual pages in specific menus, here: "Climate."

Select the symbol and press the controller:

- ▣ To proceed to the second page of the menu
- ▣ To return to the first page of the menu.

Symbols and lists

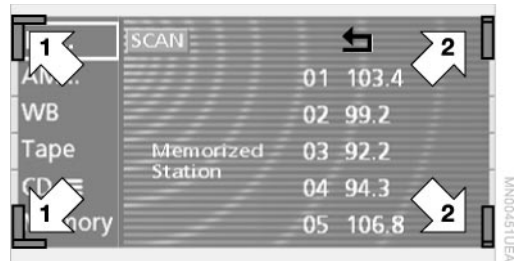

The symbols in the corners and edges of the Control Display have various functions:

1 Corner symbols:

Select these symbols to proceed to the opposite page of the menu.

To change page: turn the controller

2 List symbols:

Indicates that you can only move within the same page of the menu. You are currently in a list, for instance, stored radio stations. Turn the controller to select an entry from the list.

Select the  symbol and confirm your selection to exit from the list.

Symbols

- ▣ To proceed to the second page

 To return to the first page

 To exit from the list

 To transfer the current display to the assistance window. For more detailed information on the assistance window, refer to page [24](#)

 To transmit vehicle data to the BMW Service Center – in preparation

 For information on display units and formats, refer to page [86](#)

 Selecting language for text displays, refer to page [86](#)

 Selecting settings for vehicle functions

Menus in Control Display

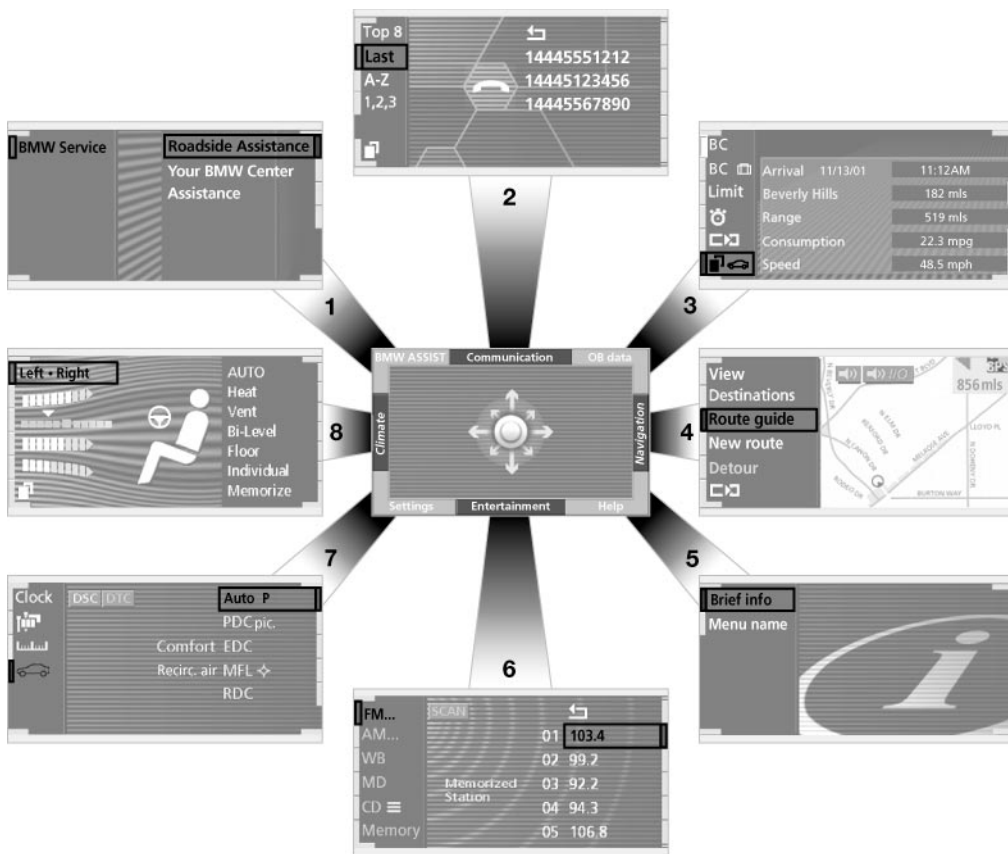

You can select from an extended range of functions and setting options:

1 BMW ASSIST – refer to the separate manual

2 Communications

- ▷ Using the mobile phone [158](#)
- ▷ Cellular phone, refer to separate Owner's manual

3 OB data

- ▷ Computer [81](#)
- ▷ Limit [84](#)
- ▷ Stopwatch [85](#)
- ▷ Service Interval Display [78](#)
- ▷ To access Check Control messages [80](#)

4 Navigation [124](#)

5 Help

- ▷ Brief "help" text displays [24](#)
- ▷ Menu name for menu change

6 Entertainment

- ▷ Radio [143](#)
- ▷ Cassette [153](#)
- ▷ CD [146, 148](#)
- ▷ MD [151](#)

7 Settings

- ▷ Time and date [86](#)
- ▷ Language [86](#)
- ▷ Units of measure and display format [86](#)

8 Climate

- ▷ Automatic climate control [99](#)
- ▷ Seat heating [50](#)
- ▷ Parked-car ventilation system [106](#)

Assistance window*

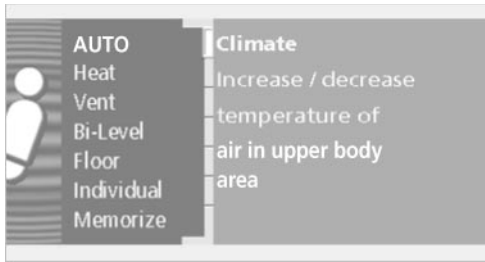

While you use the Control Center the assistance window can provide you with a parallel display for the active system.

You can use it for displays of the following:

- ▷ Short "help" and supplementary information texts for selected menu entries
- ▷ A function selected from the "OB data" menu, refer to page 85
- ▷ The travel route on vehicles equipped with a navigation system, refer to page 132.

Help texts in assistance window



You can call up and also cancel displays containing "help" and supplementary information texts on selected menu entries in the assistance window.

1. Select "Help" from the orientation menu
2. Select "Brief info" menu and confirm. The "help" texts appear in the assistance window
3. Confirm again to deactivate the automatic display.

To activate menu name



You can program the system to display the menu name each time you proceed to a new menu.

1. Select "Help" from the orientation menu
2. Select "Menu name" and confirm your entry.

Top and bottom status lines

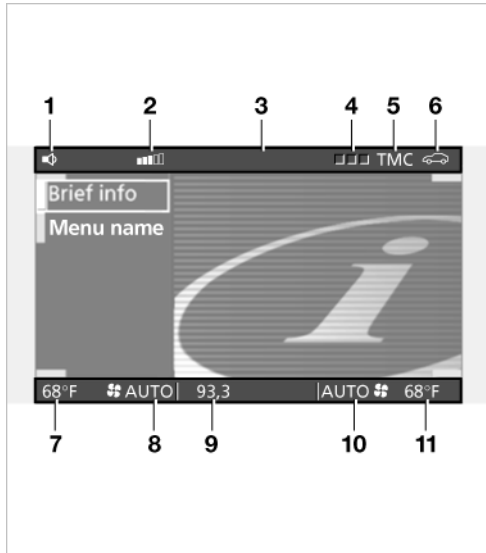

- 1 Hands-free mode active
- 2 Mobile phone reception strength
- 3 Display for phone service provider
- 4 Mobile phone status
 - ▷ Green: incoming or outgoing call
 - ▷ Red: no network available
 - ▷ Yellow: routed through alternate service network – Roaming
- 5 Traffic Message Channel activated – in preparation
- 6 Status Check Control [80](#)
 - ▷ Green: no message
 - ▷ Yellow: priority 2 – the symbol flashes briefly. You can use the "OB data" menu to have the status report shown in the Control Display
 - ▷ Red: priority 1 – these messages appear immediately, accompanied by a gong and a flashing symbol
- Status Service Interval Display [78](#)
 - ▷ Red: at least one service interval has been exceeded
- 7 Temperature selection display, left-hand side of passenger compartment
- 8 Air supply, left-hand side of passenger compartment

9 Entertainment – display for radio, cassette, CD, MD

10 Air supply, right-hand side of passenger compartment

11 Temperature selection display, right-hand side of passenger compartment.

Assistance window

The status lines in the assistance window show the following:

- ▷ Outside temperature
- ▷ Navigation system destination
- ▷ Time
- ▷ Date.

Voice command

Voice command system*

The concept

The voice command system allows you to control operation of various vehicle systems without ever removing your hands from the steering wheel. The system operates on the basis of voice commands that you will learn easily after using them a few times. You issue your commands in the form of instructions or in dialogs. The dialog functions provide you with additional support in the form of questions and information.

The voice command system transforms your commands and dialog answers into control signals for the selected systems.

 Please take the time to acquaint yourself with how a particular system operates before proceeding to control it using the voice command system. At the time of publication the voice command system was available for use with the English and German languages. Other languages are currently in preparation. When the voice command system is active you can adjust the volume, refer to page 141. ◀

Symbols used

 indicates control via the voice command system. ◀

>>...<< identifies commands used in the voice command system. It is not necessary to speak the words in parentheses.

>...< identifies the answers provided by the voice command system.

Systems available for use with voice command

- ▷ Mobile phone, refer to page 158
>>Telephone (menu)<<
- ▷ Navigation system, refer to page 124
>>Navigation (menu)<< or
>>Navi (menu)<<

- ▷ Radio, refer to page 140
>>Radio (menu)<<
- ▷ CD, refer to page 146
>>CD (menu)<<
- ▷ CD changer, refer to page 148
>>CD changer (menu)<<
- ▷ MiniDisc, refer to page 151
>>MiniDisc (menu)<<
- ▷ Cassette, refer to page 153
>>Tape (menu)<<
- ▷ Notebook, refer to page 28
>>Notepad (menu)<< or
>>Notebook (menu)<< or >>Note recorder (menu)<<

Either the system that you are now controlling, or any current error messages will appear in the Info Display, refer to page 14.

Voice commands

To activate voice command system

Activate by briefly pressing the button  in the steering wheel.

A signal tone and "SVS" in the Info Display indicate that the system is ready for use. You automatically proceed to the orientation menu.

Except in dialogs, always press the  button again before issuing voice commands.

During dialogs that include entry of text or numbers, the information that the voice command system has registered will appear on the Info Display screen, refer to page 14.

To cancel voice command entry

You can terminate execution of a command or dialog with >>Cancel<<, >>Exit<< or by pressing the  button in the steering wheel.

The  button must be used to terminate unrestricted, open dialogs in which any text might occur, such as those containing names, notes, etc.

 The system automatically switches over to its telephone mode if you receive a call during a dialog. The system issues the voice message >Cancelled< and "PROCESS TERMINATED" appears in the Info Display, see Status displays below. ◀

Voice commands

The voice command system operates on the basis of specific, predefined commands; these commands should be spoken precisely as indicated. You can listen to a selection from the command list by activating the system, refer to page 26 and issuing the command >>Options<< or >>What now<<.

The voice command system also features an entry-level >>Main menu<< that allows you to select individual accessories, refer to page 26.

Brief commands

At the >>Main menu<< level you can use "brief commands," refer to page 30 to initiate direct execution of selected functions without first proceeding to the "systems" level.

Special commands

Special commands are available for specific systems. In this Owner's Manual you will find these commands in the sections describing the individual systems.

 Instructions for using the voice command system are always identified by this pictogram. ◀

Standard commands

The standard commands available for use with all controlled systems are:

▷ >>Pardon<< or >>Repeat<<
Repeats the last message issued by the voice command system

▷ >>Cancel<< or >>Exit<<
Terminates the voice command system

▷ >>Standard dialog<<
or >>Extended dialog<<
Comprehensive instructions and error reports guide you through the system

▷ >>Short dialog<<
In this setting your guidance through the system is provided exclusively in the form of brief statements

▷ >>Help<<
Allows you to request information on various systems

▷ >>Options<< or >>What now<<
Provides you with a listing of the commands available for the selected system. A corresponding list simultaneously appears in the Info Display, see Status displays below

▷ >>Main menu<<
Provides access to submenus.

 To make it easier for you to become acquainted with the system, it is preset to the >>Standard dialog<< or >>Extended dialog<< mode at the factory. ◀

Status displays

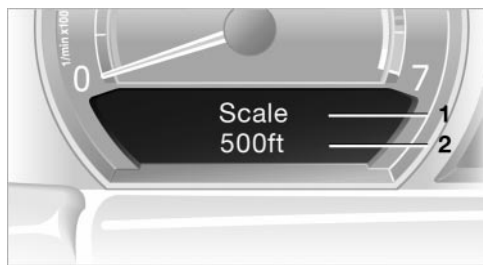

The Info Display shows you what the voice command system has understood in line 2, while also indicating which voice command or question is currently active in line 1. Any current error messages will also appear in the display panel.

Notices

 Do not use the voice command system to make emergency SOS calls. Your voice and habitual tone could be affected by stressful situations, as a result of which the process of establishing the telephone connection could be unnecessarily delayed. Instead, you should use the emergency SOS button located adjacent to the rearview mirror, refer to page 161. ◀

Environmental conditions

The voice command system uses a special microphone located on the front headliner of your vehicle. Although the system is designed to filter out ambient noise, you can help ensure that your commands will be understood by observing the following instructions:

- ▷ Speak smoothly and clearly, at a normal volume. Do not place any unusual stress on individual syllables, and avoid pauses
- ▷ Do not speak while the voice command system is talking
- ▷ Keep the doors, windows and sunroof closed to prevent interference from ambient noise
- ▷ Avoid other sources of noise in the vehicle while speaking, and ask other vehicle occupants to refrain from talking while you are using the system.
- ▷ The hands-free microphone is aimed toward the driver. This means that the system may be unable to register the voices of other vehicle occupants properly; passengers should use the mobile phone instead.

The notebook

Recording a note



>>Record note<< ◀

You can store approx. ten minutes of spoken text – either as a single entry or as multiple entries of any desired length.

To terminate recording:

Apply extended pressure to the  button.



The voice command system does not respond to the commands >>Cancel<< and >>Exit<< while you are recording a note. The standard utility that scans for system commands is deactivated in the note mode to allow you to record any text desired, without artificial restrictions. This feature saves you from having to concentrate on avoiding these words while recording. ◀

To listen to a notebook entry

Listening to recorded notebook entries:



1. >>Read out (note)<<

or >>Listen to (note)<<

The system plays back roughly the first 3 seconds of the first memorandum.

2. Respond to the query >Note and then< by selecting the desired function

▷ To listen to the entire note:

>>Read (note)<<

(>>Listen to (note)<<)

▷ To hear the next notebook entry:

>>Next note<< (>>(Note) next<<)

▷ To hear the entry again:

>>(Note) back<<

or

>>Once again<< (>>Repeat<<, >>Read out<<). ◀

To delete notes



1. >>Edit (note)<<
2. >>Delete (current note)<<. ◀

Clearing the notebook

▷ To delete all contents from the notebook:



>>Delete (note pad)<< (>>Delete (notebook)<<, >>Delete (note recorder)<< ◀

Brief commands

Function	Command
To switch on mobile phone	>>Telephone on<<
Redialing	>>Redial<<
To select from the phone directory	>>Dial name<<
Dial telephone number	>>Dial (telephone) number<<
To add new entry	>>Save name<<
To display the entry	>>Read out telephone book<<
Delete entry	>>Edit telephone book<<
To deactivate voice messages from system	>>Message (output) off<<
To activate voice messages from system	>>Message (output) on<<
To repeat previous navigation guidance instructions	>>Repeat message (output)<<
Destination entry submenu	>>(Navigation) destination entry<<
Select destination	>>Select destination<<
To change scale	>>(Change) scale<<
Starting the destination guidance system	>>Route guidance (on)<<
You are searching for a destination, but do not know the exact address	>>(Navigation) information<<
To request addresses	>>(Navigation) address book<<
Map display	>>Map<<
To switch off audio source	>>Audio off<<
To switch on radio	>>Radio on<<
Selecting radio stations	>>(Radio) frequency selection<<, >>Frequency selection<<, >>Frequency input<<

Function	Command
To select a stored radio station	>>Station<<, >>Station selection<<
To start CD	>>CD on<<
To select a CD	>>CD 1 ..6<<
To start MD	>>MiniDisc on<<
To select a track	>>MiniDisc Track 1 ..30<<
To start a cassette	>>Tape on<<
To record a notebook entry	>>Record note<<
To listen to notebook entry	>>Read out note<<, >>Listen to note<<
To edit notebook entry	>>Edit note<<

Reference	Mobility	Communications	Entertainment	Navigation	Driving tips	Controls	At a glance
-----------	----------	----------------	---------------	------------	--------------	----------	-------------





Controls

This chapter is intended to provide you with information for complete control of your vehicle. Its extensive array of features and accessories, both for driving and for your own safety, comfort and convenience, are described here.

Opening and closing

Keys



1 The Key Memory functions are controlled by the two remote control units with their integrated keys, refer to page 59. The color-coded decals that you received when taking delivery of your vehicle can be used to identify the individual remote control units

 Each remote control unit is equipped with an extended-life battery which is automatically recharged in the ignition lock each time you drive the vehicle. If you have any remote control units that are not being used on a regular basis, you should therefore remember to recharge these units by using them to drive the vehicle for an extended period at least once a year, refer to page 35. ◀

2 Spare key for storage in a safe place, such as in your wallet. This key is not intended for constant use

3 Adapter for spare key
The adapter can be used to store the spare key. It can be stored in the place provided within the luggage compartment lid-mounted onboard tool kit to ensure that it will always be available, refer to page 181. You can find more detailed information on using the adapter in the section Using the spare key adapter.

To remove the key from the remote control unit



Press the button **1** to release the key.

You can use this integrated key to lock the storage compartment located beneath the front armrest.

Within this storage compartment you will also find the switch for locking the luggage compartment separately, refer to page 39.

This precaution prevents unauthorized access to the vehicle's luggage compartment when you subsequently hand over only the remote control unit when leaving the vehicle for valet parking, etc.

Using the spare key adapter

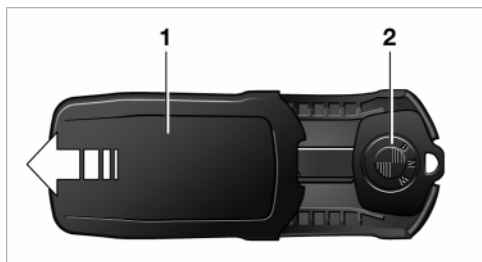

You will need the adapter to activate the ignition and to start the vehicle with the spare key.

Slide up the cover **1** and insert the spare key **2** in the adapter. Close the cover and insert the adapter in the ignition lock.

Central locking system

The concept

The central locking system is ready for operation whenever the driver's door is closed. This simultaneously engages and releases the locks on the following:

- ▷ Doors
- ▷ Luggage compartment lid
- ▷ Fuel filler door.

The central locking system can be operated

- ▷ from outside via the remote control as well as via the driver's door lock
- ▷ from inside via the button for the central locking system.

When the system is locked from inside, the fuel filler door remains unlocked, refer to page 37.

The anti-theft system is automatically armed whenever you activate the central locking system from outside the vehicle. The alarm system is armed/deactivated at the same time.

In the event of an accident, the central locking system unlocks automatically (only those doors which were not locked separately with the safety lock buttons). Refer to page 38. In addition, the hazard warning flashers and interior lamps come on.

Opening and closing – from outside

Using the remote control

The remote control makes opening and closing the doors of your vehicle very convenient. Furthermore, it provides three additional functions which you can only execute via the remote control:

- ▷ Switching on interior lamps, refer to page 36.
- You can also use this function to locate your vehicle in parking garages, etc.

- ▷ Opening and closing the luggage compartment lid, refer to pages 36, 39. The luggage compartment lid opens, regardless of whether it was previously locked.

- ▷ Panic mode

In case of danger, you can trigger an alarm.

When you engage/release the vehicle's locks, you simultaneously activate/deactivate the anti-theft system, arm/disarm the alarm system and switch the interior lamps on/off.



You can have various confirmation signals programmed into the system to verify that the vehicle has been locked securely. ◀

Remote control

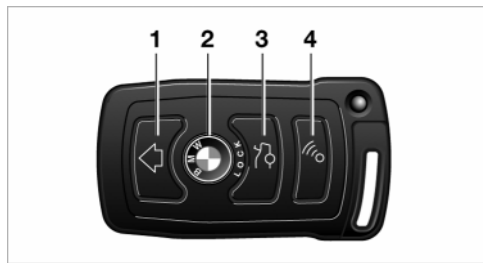

- ⚠ Because any persons or animals left unattended in a parked vehicle could lock the doors from the inside, you should always keep the remote control unit with you; this precaution ensures that you will remain able to unlock the vehicle from the outside at all times. ◀

- ▷ Because their batteries are automatically charged by the ignition lock during normal operation, remote control units that are used regularly are always charged and ready for use. When it is no longer possible to lock the vehicle via the remote control, the battery is discharged. Use this remote control unit during an extended drive; this will recharge the battery, refer to page 34. In the event of a system malfunction, please contact your BMW center, which is also your source for replacement keys. ◀

To unlock the vehicle

Press button 1.

The interior lamps and the door-mounted proximity lamps come on.

Press the button once to unlock the driver's door only; press a second time to unlock all remaining doors as well as the luggage compartment lid and the fuel filler door.

Convenience opening mode

Maintain pressure on button 1. The windows and the sliding/tilt sunroof open. The sunroof will not be retracted if it is already in its raised position.

To lock and secure

Press button 2.

To switch off the tilt alarm sensor and interior motion sensor

Press button 2 again immediately after locking. For more detailed information, refer to page 41.

To switch on interior lamps and door-mounted proximity lamps

With the vehicle locked, press button 2.

To switch on the interior lamps

Press button 4.

Panic mode

By pressing and holding button 4 for more than approx. two seconds, you can trigger the alarm system in response to any impending danger.

To switch off the alarm: press any of the buttons.

To open the luggage compartment lid

Press button 3.

The luggage compartment lid opens slightly, regardless of whether it was previously locked or unlocked.

 During opening the luggage compartment lid pivots upward and to the rear. Ensure that adequate clearance is available before opening.

To avoid being inadvertently locked out, never lay the remote control unit down in the luggage compartment. If the luggage compartment lid was locked earlier, it will relock automatically when closed. ◀

Automatic luggage compartment lid operation***To open the luggage compartment lid**

Press button 3.

The luggage compartment lid opens all the way, regardless of whether it was previously locked or unlocked.

To interrupt the opening process:

Press the button again while opening is in progress.

 During opening the luggage compartment lid pivots upward and to the rear. Ensure that adequate clearance is available before opening.

To avoid being inadvertently locked out, never lay the remote control unit down in the luggage compartment. If the luggage compartment lid was locked earlier, it will relock automatically when closed. ◀

External systems

External systems or devices may cause local interference in the functions of the remote control.

Should the remote control unit fail to operate owing to interference of this kind, you can respond by using the key to unlock your vehicle at one of the doors.

For US owners only

The transmitter and receiver units comply with Section 15 of the FCC/Federal Communication Commission regulations. Operation is governed by the following:

FCC ID: LX8765S
 LX8765E
 LX8CAS

Compliance statement:

This device complies with part 15 of the FCC Rules. Operation is subject to the following two conditions:

- ▷ This device may not cause harmful interference, and
- ▷ this device must accept any interference received, including interference that may cause undesired operation.

 Any unauthorized modifications or changes to these devices could void the user's authority to operate this equipment. ◀

Using the key

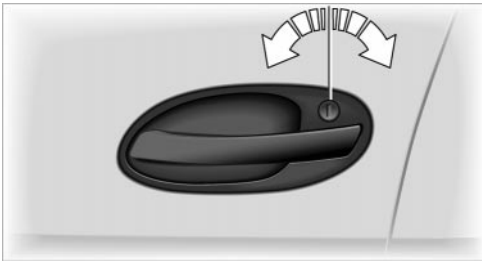

One turn of the key in the driver's door lock unlocks the driver's door only.

Turning the key a second time unlocks all of the remaining doors, the luggage compartment lid and the fuel filler door.



You can have a signal set as an acknowledgment message that the vehicle is closed correctly. ◀

Convenience operation

You also have the option of operating the windows and the sliding/tilt sunroof from the driver's door lock.

- ▷ To open:

With the door closed, turn the key to the "unlock" position and hold it there

- ▷ To close:

With the door closed, turn the key to the "lock" position and hold it there.



Watch during the closing process to be sure that no one is injured.

Releasing the key stops the operation. ◀



Manual operation

(in the event of an electrical malfunction)



You can turn the key all the way to the right or left in the door lock or engage or release the locking mechanism in the driver's door.

Opening and closing – from inside



You can operate the central locking system with this button when the driver's door is closed. This unlocks  or locks  the doors and luggage compartment, but does not activate the anti-theft system.

The anti-theft system is not activated. Also, the fuel filler door remains unlocked to allow refueling.

 After unlocking the driver's door with the remote control, refer to page 36, you can press the button  to unlock all remaining doors as well as the luggage compartment lid and the fuel filler door. After closing the driver's door you can press  to lock it. ◀



You can also have the system programmed to activate the central locking system automatically whenever the vehicle is set in motion, or when a specific interval elapses after it is unlocked, provided that neither the doors nor the luggage compartment lid are opened in the meantime. This can be adjusted to be key-specific. ◀

To unlock and open the doors

- ▷ Either unlock the doors together with the button for the central locking system and

then pull the release handle above the armrest
or

▷ pull the release handle for each door twice: the first pull unlocks the door, and the second one opens it.

▷ When the low beams are switched on, the interior door handles are also lighted. The intensity of the lighting is adjusted together the instrument lighting, refer to page 97. ◀

To engage locks

▷ Use the central locking button to lock all of the doors simultaneously,
or

▷ press the individual safety lock buttons down. To prevent the driver from being inadvertently locked out of the vehicle, the lock button on the driver's door automatically extends again after a brief period if the door remains open.

⚠ Do not use the safety lock buttons to engage the locks for driving, as they would then fail to disengage automatically in the event of an accident.

Because any persons or animals left unattended in a parked vehicle could lock the doors from the inside, you should always keep the remote control unit with you; this precaution ensures that you will remain able to unlock the vehicle from the outside at all times. ◀

Doors

Soft Close Automatic*

Apply gentle pressure to the door to close it. The closing process will then be carried out automatically.

⚠ To avoid injuries, ensure that the door's travel path is completely free and clear before closing. ◀

Luggage compartment lid

Opening from outside

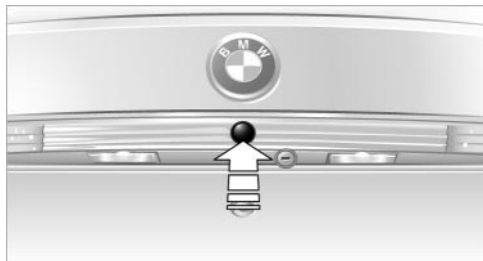

Press the button, see arrow in illustration. The luggage compartment lid opens.

▷ During opening the luggage compartment lid pivots upward and to the rear. Ensure that adequate clearance is available before opening. ◀

The lock

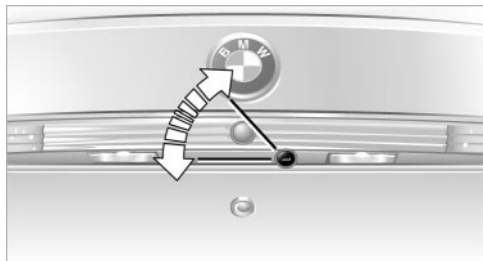

All of the vehicle's keys fit the luggage compartment lid lock located in the license plate recess.

Opening separately

Insert the key in the luggage compartment lid's lock and turn it all the way to the right – the lid opens.

▷ To avoid being locked out inadvertently, avoid laying the remote control unit down in the luggage compartment. The luggage compartment is locked again as soon as you close the lid.

If you use the key to unlock the luggage compartment lid while the alarm system is armed, the alarm will be triggered. To deactivate the alarm,

- ▷ unlock the vehicle using the remote control, refer to page 36, or
- ▷ insert the remote control all the way into the ignition lock, engaging the detent. ◀

Secure separately

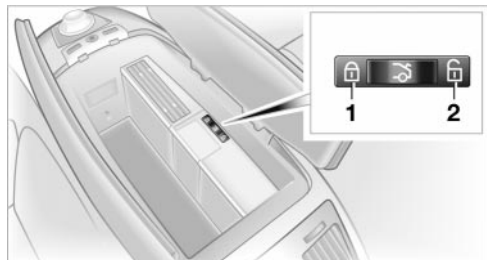

The switch position will vary according to the individual vehicle's equipment level.

- 1 Luggage compartment lid locked
- 2 Luggage compartment lid unlocked

Push the switch into position 1. This locks the luggage compartment lid and disconnects it from the central locking system.

If you then lock the storage compartment in the center armrest before handing over only the remote control when leaving the vehicle for valet parking, etc., this will prevent unauthorized access to the vehicle through the luggage compartment, refer to page 34.

Manual operation

(in the event of an electrical malfunction)
Refer to section on Opening separately.

To open from the inside



You can use this button to open the luggage compartment lid when the vehicle

is stationary (not possible, if the luggage compartment lid has been locked separately).

To close



A recess has been incorporated into the inside trim on the luggage compartment lid to make it easier to pull down.

Automatic Soft Close feature

To close the luggage compartment lid, merely press it down gently. The closing process will then be carried out automatically.

⚠ To avoid personal injury, always ensure that no individuals are within the luggage compartment lid's travel range when closing.

Operate the vehicle only when the luggage compartment lid is completely closed. Otherwise, exhaust fumes could penetrate the interior of the vehicle. If special circumstances should make it absolutely necessary to operate the vehicle with the luggage compartment lid open:

- ▷ Close all windows. Shut the sliding/tilt sunroof
- ▷ Increase the air supply of the automatic climate control to a high level, refer to page 101. ◀

Automatic luggage compartment lid operation*

To open

The luggage compartment lid opens all the way, when you

- ▷ press the button next to the steering column

- ▷ press the button on the outside of the luggage compartment lid, refer to page 38
- ▷ press the button **3**  on the remote control unit, refer to page 36.

 During opening the luggage compartment lid pivots upward and to the rear. Ensure that adequate clearance is available before opening. ◀

To close

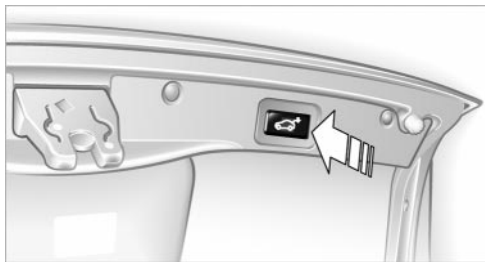

The luggage compartment lid closes automatically when you

- ▷ press the button, refer to arrow, or
- ▷ press the button on the outside of the lid, refer to page 38.

 The luggage compartment lid immediately stops opening or closing if you hold it in place by hand. ◀

 To avoid injuries, be sure that the travel path of the luggage compartment lid is clear when it is closed, as with all closing procedures.

Operate the vehicle only when the luggage compartment lid is completely closed. Otherwise, exhaust fumes could penetrate the interior of the vehicle. If special circumstances should make it absolutely necessary to operate the vehicle with the luggage compartment lid open:

- ▷ Close all windows. Shut the sliding/tilt sunroof
- ▷ Increase the air supply of the automatic climate control to a high level, refer to page 101. ◀

Manual operation

(in the event of an electrical malfunction)

Use the key to unlock the luggage compartment lid, refer to page 38, and then slowly open or close it, taking care to avoid abrupt motion in the process.

Emergency release



This lever releases the luggage compartment lid from inside the luggage compartment.

Luggage compartment

Net*

You can use the net to store smaller objects on the bulkhead separating the luggage compartment from the rear seats.

Alarm system

The concept

The vehicle alarm system responds:

- ▷ When a door, the hood, or the luggage compartment lid is opened
- ▷ To movement in the vehicle's interior – interior motion sensor
- ▷ Changing the vehicle's tilt if someone attempts to steal the wheels or tow the vehicle
- ▷ To interruption of battery voltage.

The system responds to unauthorized vehicle entry and attempted theft by simultaneously activating:

- ▷ An acoustic alarm, which lasts for a period of roughly 30 seconds

- ▷ The hazard warning flashers for approx. five minutes
- ▷ The high beams, which flash on and off in the same rhythm.

To arm and disarm the alarm system

When you lock (or unlock) the vehicle, either with the remote control unit or at the door lock, the alarm system is armed (or disarmed) at the same time.

The system indicates that it has been correctly armed by switching on the hazard warning flashers for a single cycle and by emitting an acoustic signal.



You can have different acknowledgment signals set to confirm arming and disarming. ◀

Even with the alarm system armed, you can open the luggage compartment lid using the button **3**  on the remote control unit, refer to page 36. The alarm system will start to monitor the luggage compartment lid again as soon as it is reclosed.

Indicator lamp displays

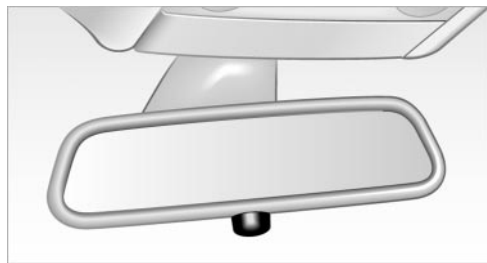

MAN007383CAN

- ▷ The indicator lamp below the interior rearview mirror flashes continuously: the system is armed
- ▷ The indicator lamp flashes when the system is armed: door(s), the hood or luggage compartment lid are not completely closed. Even if you do not close the alerted area, the system begins to monitor the remaining areas, and the indicator lamp flashes continuously after 10 seconds. However, the interior motion sensor is not activated

- ▷ If the indicator lamp goes out when the system is disarmed: no manipulation or attempted intrusions have been detected in the period since the system was armed
- ▷ If the indicator lamp flashes for roughly 5 minutes when you disarm the system, or until the remote control unit is inserted in the ignition lock: an attempted entry has been detected in the period since the system was armed.

Following triggering of an alarm, the indicator lamp will flash continuously.

Avoiding unintentional alarms

The tilt alarm sensor and interior motion sensor may be switched off at the same time. You can do this to prevent a false alarm from being triggered (in garages with elevator ramps, for instance), or when the vehicle is transported by trailer or train:

Lock the vehicle, i. e., arm the alarm system twice in a row by pressing button **2** on the remote control unit twice in succession, refer to page 36, or lock the vehicle twice using the key, refer to page 37.

The indicator lamp flashes briefly and then flashes continuously. The tilt alarm sensor and the interior motion sensor are switched off long as the system is armed.



If you desire, the

- ▷ tilt alarm sensor, and
- ▷ interior motion sensor

can be switched off permanently. Please contact your BMW center for assistance. ◀

Interior motion sensor

In order for the interior motion sensor to function properly, the windows and sliding/tilt sunroof must be completely closed.

Be sure to deactivate the interior motion sensor, see section on Avoiding unintentional alarms, when you wish to leave the windows or sliding/tilt sunroof open.

Electric power windows

Open and close windows



From "radio" mode on:

- ▷ Press the switch until you feel resistance:
The window continues to move as long as you continue to hold the switch
- ▷ Press the switch beyond the resistance point:
The window moves downward automatically. Press the switch again to stop the opening movement.

You can close the windows in the same manner by pulling the switch.

The power windows remain available for use after the ignition is switched off:

- ▷ for approx. 15 minutes with the remote control unit in the "radio" mode
- ▷ for approx. 1 minute in position 0 or with the remote control unit disengaged.

To open, press the switch beyond the pressure point.

 When leaving the vehicle parked, always remove the remote control from the ignition lock and close the doors; this precaution prevents children from operating the power windows and injuring themselves, etc. ◀

For information on using the convenience operation mode at the door lock or with the remote control unit, refer to page 37 or 36.

Safety feature

If the force rises beyond a predefined threshold during closing, the system will

immediately stop moving the window prior to lowering it slightly.

 Despite this safety feature you should always inspect the window's travel path prior to closing it, as the safety system might fail to detect certain kinds of obstructions, such as very thin objects, and the window would continue closing. Pulling the switch beyond the pressure point and holding it limits the response of the safety feature. Under these conditions the window will respond to forces beyond a defined threshold by only opening several millimeters.

If you again pull the switch past the pressure point and hold it in position within a period of roughly 4 seconds, the safety feature will be deactivated. ◀

 If you desire, you can have your BMW center reprogram the safety feature for deactivation the first time you pull and hold the switch. Please contact your BMW center for assistance. ◀

 When you close the windows they will slow down as they approach the end of their travel; this is to allow the safety feature to respond more precisely to any obstructions encountered in this critical range. ◀

Safety switch



With the safety switch, you can prevent the rear windows from being opened or closed via the switches in the rear passenger area (by children, for example). The switch also deactivates the rear-mounted switches controlling the rear seats' power adjustment, refer to page 47, and the rear window sun blinds, refer to page 109. The

indicator lamp lights up when this safety feature is activated.

 Press the safety switch whenever children are riding in the rear of the vehicle. Careless use of the power windows can lead to injury. ◀

 The remote control unit must be locked in position in the ignition lock before this safety feature can be deactivated. ◀

After installing accessories

After installing any accessory – such as a clamp-on antenna for a mobile phone – within the window's travel range, you will need to have the system reinitialized for use under the new conditions. Please contact your BMW center for assistance.

Sliding/tilt sunroof*

 To prevent injuries, exercise care when closing the sliding/tilt sunroof and keep it in your field of vision until it is shut.

When leaving the vehicle, always disengage the remote control in the ignition lock and close the doors to prevent children from operating the sunroof and injuring themselves, etc. ◀

Raising – Opening – Closing

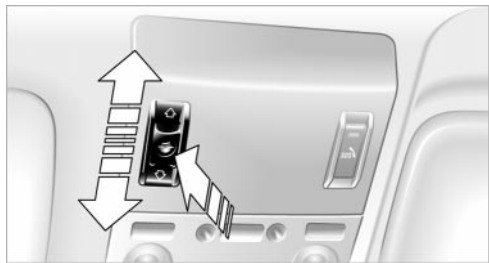

From "radio" mode on, press the switch, or slide in the desired direction up to the pressure point.

After the ignition is switched off the sunroof remains available for operation:

▷ for approx. 15 minutes with the remote control unit in the "radio" position

▷ for approx. 1 minute in position 0 or with the remote control unit disengaged.

The headliner insert slides back somewhat when you raise the sunroof. When the sunroof is opened the headliner retracts with it.

 Do not use force to close the headliner insert with the sunroof in its raised position, as damage to the mechanism could result. ◀

For information on using the convenience operation mode at the door lock or with the remote control, refer to page 37 or 36.

Automatic* opening and closing

Press the switch past the pressure point and then release it.

In addition, the following response is also automatic:

With the sunroof open, press the switch in the "raise" direction: the sunroof rises to its tilt-up end position.

Press the switch again in any direction to stop the sunroof.

 The automatic opening feature in the "raise" direction can be deactivated. Please contact your BMW center for assistance. ◀

Safety feature

If the sliding/tilt sunroof encounters resistance

▷ when it is closing from the raised position

▷ when it is closing from a point roughly past the middle of its travel,

the closing cycle is interrupted and the sliding/tilt sunroof will open again slightly.

 Despite this safety feature you should always inspect the sunroof's travel range prior to closing it, as the safety feature might fail to detect certain kinds of obstructions, such as very thin objects, and the sunroof would continue closing. Pressing the switch beyond the pressure

point and holding it limits the response of the safety feature. The sunroof only opens a short distance.

If you again press the switch past the pressure point and hold it in position within about 1.5 seconds, the safety feature will be deactivated. ◀

 When you close the sliding/tilt-sunroof it will slow down as it approaches the end of its travel path; this is to allow the safety feature to respond more precisely to any obstructions encountered in this critical range. ◀

Following interruptions in electrical power supply

Following interruptions in electrical power (for instance, when the battery is disconnected), it is possible that the sliding/tilt-sunroof will extend to its tilt-up position, but fail to respond to other commands. Should this occur, please have the sunroof reinitialized at your BMW center.

Malfunctions

In the event of an electrical malfunction, you can operate the sliding/tilt sunroof manually:

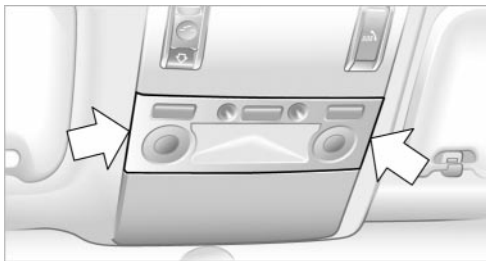

1. Remove the interior lamp and reach into the opening to press out the cover

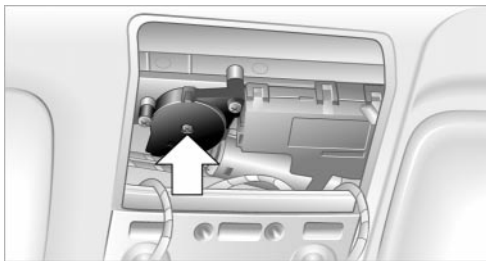

Adjustments

Correct sitting position

The ideal sitting position can make a vital contribution to relaxed, fatigue-free driving. The correct sitting position also works together with the safety belts and airbags to provide occupants with maximum levels of passive safety in an accident. To ensure that the safety systems operate with optimal efficiency, we strongly urge you to observe the instructions contained in the following section.

For additional information on transporting children safely, refer to page [57](#).

Correct sitting position with airbags

 Always maintain an adequate distance between yourself and the airbags. Always hold the steering wheel by its rim with hands at the 9 o'clock and 3 o'clock positions, to minimize the risk of injuries to your hands and arms in the event of airbag deployment. No one and nothing is to come between the airbags and the seat occupant.

To prevent possible leg injuries should the knee airbag deploy in an accident, ensure that the front passenger assumes a correct sitting position. Do not use the cover of the front airbag on the front passenger side as a storage area for objects, or as a rest for feet or legs. ◀

For airbag locations and additional information on airbags, refer to page [55](#).

Correct sitting position with safety belts

For the safety of all vehicle occupants, please comply with the following instructions for wearing safety belts.

 Never allow more than one person to wear a single safety belt. Never allow infants or small children to ride in a passenger's lap. Avoid twisting the belt while routing it firmly across the hips and shoulder. Wear it as snugly against your

body as possible. Do not allow the belt to rest against hard or fragile objects.

Do not route the belt across your neck, or run it across sharp edges. Be sure that the belt does not become caught or jammed. Avoid wearing loose or bulky clothing that would prevent the belt from resting securely against your body; pull on the shoulder strap periodically to keep it tensioned. In the event of a frontal impact, a loose lap belt could slide over your hips, leading to abdominal injury. In addition, the safety belt's restraint effectiveness is reduced if the belt is worn loosely. Expectant mothers should always wear their safety belts, taking care to position the lap belt against the lower hips, where it will not exert pressure against the abdominal area. ◀

For putting on safety belts, refer to page [50](#).

Seats

For your personal safety when adjusting the seat position, please follow the instructions below carefully.

 Never attempt to adjust your seat while operating the vehicle. The seat could respond with unexpected movement, and the ensuing loss of vehicle control could lead to an accident. Never recline the backrest to an extremely horizontal position while the vehicle is underway – this precaution is especially important for front passengers and the occupants of electric power rear seats to remember. Failure to observe these precautions can prevent the belts from providing effective protection against injury, as passengers could slide under the belts in an accident. ◀

Please observe the information on using safety belts provided on page [50](#) and the

notice on the active head restraints on page 48.

The concept

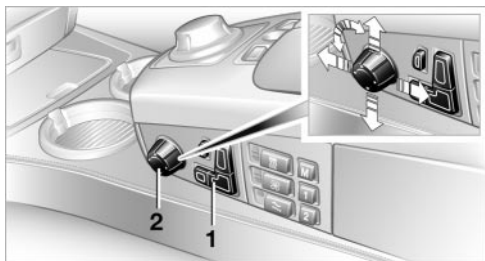

You adjust the seat in two stages:

1 Preselect the function: the button lights up brightly

2 Adjustments: slide control knob to

- ▷ front or rear ◀▶ or
- ▷ up or down ▲▼
- ▷ or rotate ▶◀

Electric power seat adjustment

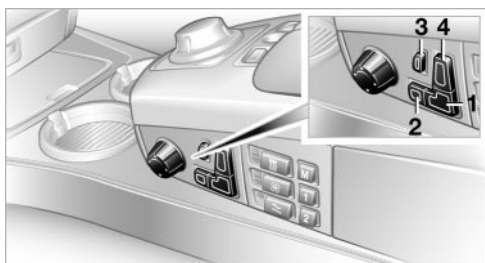

You can use the control knob to adjust various functions after first selecting them with the buttons.

⚠ To ensure that the safety systems continue to provide optimal protection, please observe the adjustment instructions on page 45. ◀

1 Forward/backward: ◀▶

Height: ▲▼

Backrest: ▶◀

This button is always ready for operation

2 Thigh support: ◀▶

Height: ▲▼

Tilt angle – driver's seat only: ▶◀

3 Lumbar support*: see below

Comfort seat* front adjustment

In addition to the electric power seat functions, several other adjustment options are also available with the comfort seat:

2 Thigh support: ◀▶

Tilt angle – also on front passenger's side: ▶◀

3 Lumbar support, see below

Backrest width:

Increase or decrease lateral support ▶◀

4 Shoulder support, see below

Head restraint height ▲▼

Backrest: ▶◀

Lumbar support adjustment

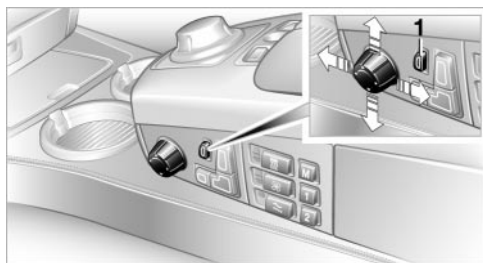

1 Lumbar support

You can also adjust the contours of the backrest to obtain additional support in the lumbar region.

The upper hips and spinal column receive supplementary support to help you maintain a relaxed, upright sitting position.

◀▶ Increase or decrease curvature

▲▼ Increase curvature at top or bottom.

Shoulder support adjustment

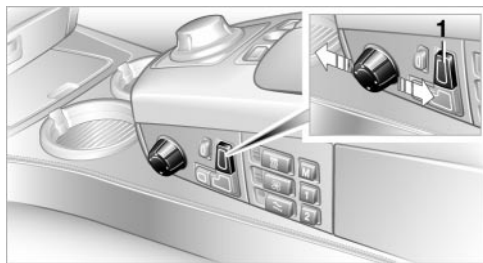

1 Shoulder support: ◀▶

You can use the adjustable upper backrest for supplementary support in the shoulder region. This provides a relaxed driving position and helps relieve stress on the shoulder muscles.

 Make corrections in the forward/backward adjustment of the seat to ensure that the safety belt still fits firmly against your body. If you do not do this, the protection provided by the safety belt may be reduced. ◀

Rear comfort seat* adjustment

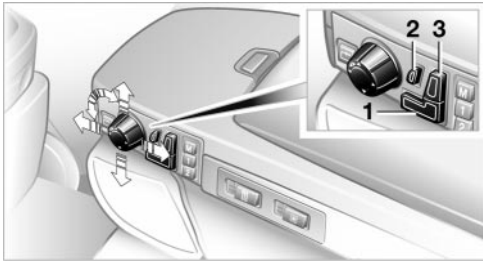

You can use the control knob to adjust various functions after first selecting them with the buttons.

1 Forward/backward: ◀▶

Tilt angle: ▲▼

Backrest: ▶◀

This button is always ready for operation

2 Lumbar support, refer to page 46

3 Shoulder support: ◀▶

Head restraint height: ▲▼

Backrest: ▶◀

 It is not possible to adjust the comfort seats if the safety switch for the power windows has been depressed, refer to page 42. ◀

Adjusting passenger seat from the rear

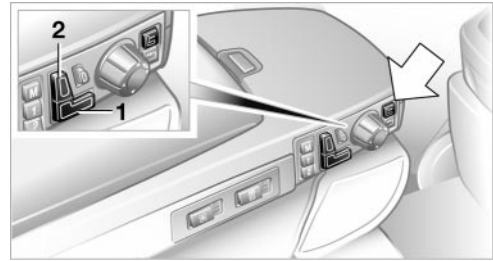

The front passenger's seat can be adjusted from the rear seating positions, for instance, when a rear passenger desires more legroom.

Press the button to activate this function, refer to arrow.

You can use the control knob to adjust the settings after selecting the desired function with the buttons.

1 Forward/backward: ◀▶

Height: ▲▼

Backrest: ▶◀

2 Head restraint height: ▲▼

Press the button (see arrow) again to deactivate this function.

Resetting to standard adjustment position



You can use the button to return the rear seats to their standard, or default positions. Maintain pressure on the button until the system completes the adjustment.

 It will be necessary to return the rear seats to their standard position before using a child-restraint system (for instance), refer to page 57. ◀

Head restraints

Adjustment information

 Head restraints can reduce the risk of spinal injury in the event of an accident.

Adjust the head restraints so that they are centered roughly at the level of your ears. ◀

Electric power seat, comfort seat

Height adjustment

The head restraint automatically adjusts to the standard height for the seat's current forward/backward adjustment.

 You can then adjust the height of the head restraint by hand or using the electric switch as required. ◀



To adjust head restraint tilt angle: adjust by tilting the head restraint.

To adjust side extensions

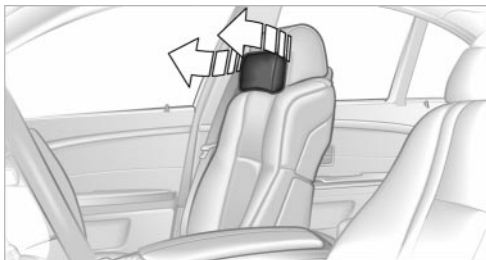

You can fold the side extensions on the head restraint forward for increased lateral support.

Front head restraints, active*

When necessary, the system will respond to a rear impact by automatically triggering the active head restraints.

 To ensure that the active head restraints afford maximum protection, and to avoid unnecessary risks to personal safety, we request that you read and comply with the following.

- ▷ Adjust the head restraints so that they are centered at roughly ear height
- ▷ Do not install seat or head-restraint covers
- ▷ Never use the head restraints as supports for suspending objects of any kind, such as clothes hangers. Refrain from mounting accessories on either the seat or the head restraint. ◀

Rear seats

Manual adjustment

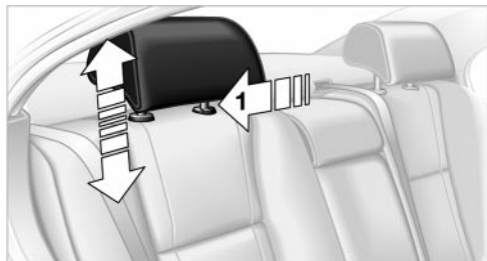

- ▷ To raise: pull
- ▷ To lower: press the button, arrow 1, and push down the head restraint.

To remove head restraints, refer to page 49.

Adjusting the center head restraint

 If the head restraint has been lowered, pull it back up, continuing until the detent engages, before allowing a passenger to ride in the rear center position. Failure to observe this precaution can reduce the level of occupant protection. ◀

Electrical adjustment*



▶ The head restraints at the outside seating positions extend automatically whenever the system detects a passenger on the seat. ◀

⚠ To prevent possible personal injury and property damage, always ensure that the area above the head restraints is clear and unobstructed before extending them upward. ◀

Manual head restraint removal and installation

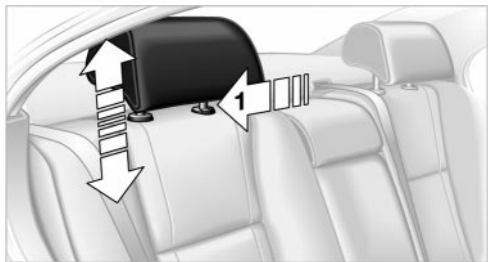

Removal

1. Pull the head restraint upward to the stop
2. Press the button, arrow 1, and remove the head restraint.

Installation

1. Press the button, arrow 1, and slide the head restraint into its support
2. Adjust the head restraint for your personal comfort.

Comfort seat in rear*

Height adjustment

If necessary, adjust the head restraint's height to ensure that it is centered at roughly the height of the passenger's ears.

▶ The head restraints at the outside seating positions extend automatically whenever the system detects a passenger on the seat. You can then adjust the head restraint's height manually, if necessary. ◀

⚠ To prevent possible personal injury and property damage, always ensure that the area above the head restraints is clear and unobstructed before extending them upward. ◀

To adjust side extensions



You can fold the side extensions on the head restraint forward to increase lateral support.

Safety belts



Despite the presence of airbags, you should always remember to fasten your safety belt before starting off; airbags are intended to enhance the protection provided by the safety belts, and not to replace them.

To fasten

Make sure you hear the latch plate engage in the belt buckle.



Warning lamp: Please fasten safety belts. Accompanied by a signal and/or a message in the Check Control display. Remains on until the safety belts are fastened.

To release

Press the red button in the buckle. Hold the belt and guide it back into its reel.

The shoulder strap's anchorage point will be in the correct position for seat occupants of every build if the seat is correctly adjusted, refer to page 45.

The two rear safety belt buckles integrated in the rear seat are for passengers sitting on the left and right. The belt buckle

embossed with the word CENTER is intended exclusively for use by passengers riding in the center position.

Please remember to observe the instructions for seat adjustment found on page 45.



If the safety belts are damaged or stretched in an accident: have the entire belt system, including the tensioning mechanisms and any installed child-restraint systems, replaced at your BMW center. Have the belt anchorage points inspected for damage at the same time. Failure to observe this precaution may prevent the safety belts from effectively providing optimal protection when needed. ◀

Rear seats



When the rear center position is not occupied, the latch on the safety belt can be inserted in the slot between the seat's upholstery and the backrest. ◀

Heated seats*

Front



The system regulates the temperatures of the seat cushion and backrest.

The temperature setting progresses one step through its control sequence each time you press the button.

To switch off :

Maintain pressure on the button for several seconds.

Rear



The operating concept is the same as for the front seat heaters.

Front temperature distribution

It is possible to select a temperature-distribution pattern providing different levels of heating for the seat cushion and the backrest, for instance, to adapt for different clothing on the legs and upper body.

1. Select "Climate" menu
2.  Select and confirm your selection

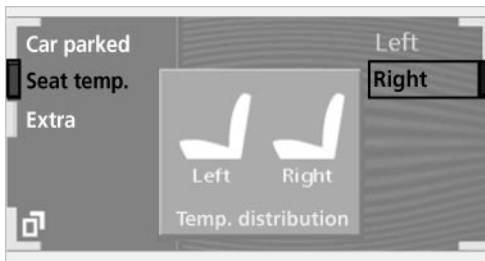

3. Select "Seat temp." and confirm
4. Select "Left" or "Right" and confirm
5. Turn to adjust temperature distribution
6. Press to confirm your entry.

 The system automatically selects your individual temperature distribution settings each time you unlock the vehicle using your personal remote-control unit. ◀

Active seat ventilation*



Front

The system progresses one step through the control sequence each time you press the button.

To switch off:

Maintain pressure on the button for several seconds.

 Use level 3 to cool the passenger compartment rapidly, for instance, when heat accumulates in the vehicle while it is parked. The system automatically reverts to operation at level 2 after a brief period. ◀

Rear



The operating concept is the same as that for the front seat ventilation.

Active seat*



"Active" adjustment of the seat cushion's contours reduces muscular tension and fatigue to help prevent lower back pain.

To activate: press the button, the indicator lamp comes on.

Mirror

Adjusting exterior mirrors



1 4-way adjustment

2 To select mirror for adjustment

⚠ To prevent the exterior mirrors on this vehicle from being damaged, always fold them in by hand before entering an automatic car wash. ◀

You can also adjust the mirrors manually by pressing against the outer edges of their lenses.

Storing the mirror positions, refer to seat, mirror and steering wheel memory on page 54.

⚠ The mirror on the passenger's side features a lens with a more convex surface than the mirror installed on the driver's side. When estimating the distance

between yourself and other traffic, bear in mind that the objects reflected in the mirror are closer than they appear. This means that estimations of the distance to following traffic should not be regarded as precise. ◀

Self-defrosting mirrors

The mirrors are automatically heated whenever the ignition is switched on.

Interior and exterior mirrors, automatic dimming feature*

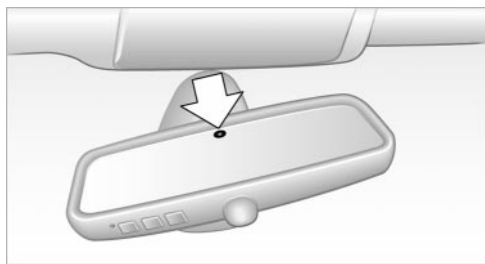

These mirrors automatically respond to ambient light and headlamp glare from following vehicles by automatically dimming through an infinitely-variable range. There are two photocells located in the interior rearview mirror for this purpose. One is integrated within the mirror's lens (arrow), while the other is located at an offset position on the rear of the mirror housing.

The mirrors automatically revert to their clear, undimmed mode whenever you place the selector lever into reverse.

▶ For trouble-free operation, keep the photocells clean and do not cover the area between the interior rearview mirror and the windshield. Do not attach any kind of stickers on the windshield in front of the mirror, either. ◀

Lighted vanity mirror

In rear

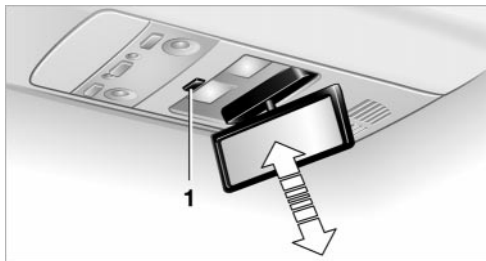

1. Press button 1. The vanity mirror folds down
2. Pull the mirror down slightly before proceeding to turn it or tilt it into the desired position
3. Press the vanity mirror back up before folding it back in.

The mirror is illuminated from the radio mode on.

Steering wheel adjustment



The steering wheel can be adjusted in any of four directions by pressing the appropriate end of the button.

⚠ Do not adjust the steering wheel while the vehicle is moving. There is a risk of accident from unexpected movement. ◀

Storing steering wheel positions, refer to Seat, mirror and steering wheel memory on page 54.

Automatic steering wheel adjustment

The steering wheel automatically moves as high up and far forward as possible to ease driver entry and exit before then returning to the standard position or stored memory setting.

This automatic feature is governed by the door and the ignition switch.

Heated steering wheel*



The steering wheel's heater operates when the ignition is on.

Press the button to activate or deactivate this system.

The indicator lamp within the button lights up when the steering wheel heater is in operation.

Programming button function



You can assign specific individual functions to the programmable button. This feature then provides you with quick access to this function, allowing you to control it without undue distraction from road and traffic conditions.



1. Select "Settings" menu
2. Confirm your selection

3. Select "MFL." Continue to press the controller until the desired function appears:

▷ "Recirc. air"

In this mode the supply of outside air remains blocked, refer to AUC Automatic recirculated-air control on page 101

▷ "Navi info"

To repeat the most recent message from the navigation system, refer to page 133

▷ "AUTO P"

To activate/deactivate Automatic Hold refer to Automatic Hold on page 63.

You can select the displayed function using button 1 in the steering wheel.

▷ If you have activated the Automatic hold feature, refer to page 63, you can use button 1 to deactivate the system for parking maneuvers, etc. ◀

Seat, mirror and steering wheel memory

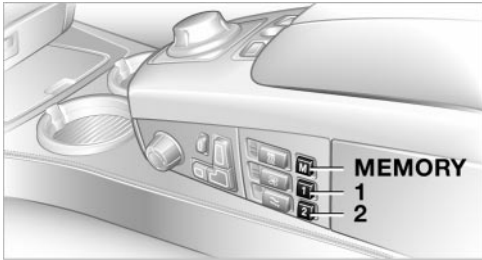

You can store two and select two different adjustment settings for the driver's seat, exterior mirrors and steering wheel.

The adjustment of the lumbar support is not stored in the memory.

To store

1. Radio mode, or switch on ignition
2. Settings for the preferred seat, exterior mirror and steering wheel positions
3. Press MEMORY button:
The indicator lamp within the button comes on

4. Press the desired memory button, 1 or 2:

The indicator lamp goes out.

To select a stored setting

Convenience mode

1. Driver's door opened after unlocking, or power supply in position 1
2. Briefly press the desired memory button, 1 or 2.

The system immediately cancels the adjustment procedure when you press one of the seat adjustment buttons or use one of the memory buttons.

Safety feature

1. Driver's door closed and power supply either in position 0 or 2
2. Press memory button 1 or 2 and maintain pressure until the adjustment process has been completed.

If you press the MEMORY button accidentally:

Press the button again; the indicator lamp goes out.

 Do not call up a position from the memory while the vehicle is moving. There is a risk of accident from unexpected movement of the seat or steering wheel. ◀

 You can have your vehicle programmed to automatically dial in your own individual adjustment settings for the seat, mirrors and steering wheel whenever you use your personal remote control unit to unlock the vehicle. ◀

 When using the Key Memory feature always make sure that the footwell behind the driver's seat is empty and unobstructed. If you fail to do so, any persons or objects behind the seat could be injured or damaged by a rearward movement of the seat. ◀

Passenger-side exterior mirror tilt function

Automatic curb monitor

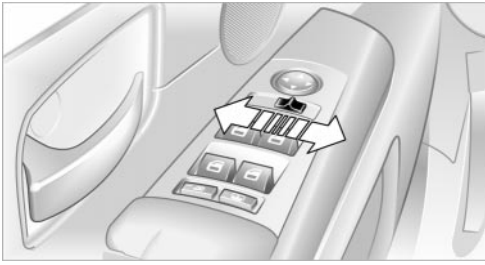

1. Select the driver's door mirror with the switch
2. When you tap the selector lever to select reverse, the door mirror on the passenger side tilts downward. This allows the driver to see the area immediately adjacent to the vehicle – such as a curb – when parking, etc.

You can deactivate this automatic feature: Slide the mirror selection switch to the "passenger's side" position.

Airbags

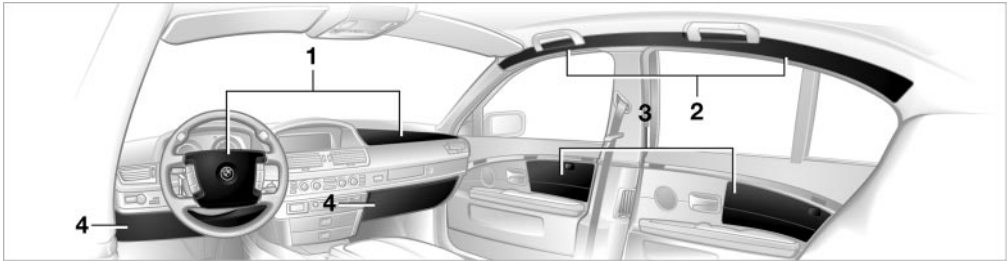

- 1 Front airbags for driver and front passenger
- 2 Head airbags in front and rear*
- 3 Side airbags in front and rear*
- 4 Knee airbags for driver and front passenger

Airbags are located under the upholstery covers on the steering wheel, in the instrument panel, in the door trim panels in front and rear*, on the roof pillars and the sides of the headliner.

Protective effect

The front airbags protect the front passengers by responding to frontal impacts in which safety belts alone cannot provide adequate restraint. When needed, the head and side airbags help provide protection in the event of side impact. The side airbags help restrain the side of the occupant's upper torso, and the head airbags help support the head while also helping provide protection against any objects penetrating into the passenger compart-

ment. The knee airbags help protect the legs against impact against the cockpit.

 The side airbags in the rear passenger area of your vehicle may already have been deactivated either at the time of manufacture or by a BMW center. You may have them activated if you desire to do so. Please contact your BMW center for additional information. ◀

For information on the proper sitting position, refer to page 45.

 The airbags do not deploy in response to minor collisions or rear impacts, nor do they respond to certain kinds of vehicle rollover. ◀

Even when all safety guidelines are observed, there is a small residual risk that passengers will sustain facial, hand or arm injuries in isolated instances. The ignition and inflation noise may provoke a mild temporary hearing loss in extremely sensitive individuals.

Important safety notes

 Do not apply adhesive materials to the cover panels of the airbags, cover them or modify them in any other way. Do not attempt to remove the airbag restraint system from the vehicle. If you note any indication of system malfunction, if you desire to have an airbag deactivated, or if the airbags are triggered in response to an accident, you should always entrust all inspection, repair and dismantling operations to your BMW center.

Never modify or tamper with either the wiring or the individual components in the airbag system. This category includes the upholstery in the center of the steering wheel, on the instrument panel, the side trim panels on the front and rear doors, and the roof pillars along with the sides of the headliner. Do not attempt to remove or dismantle the steering wheel.

To ensure compliance with official safety regulations, entrust disposal of airbag generators to a BMW center.

Unprofessional attempts to service the system could lead to failure in an emergency or undesired airbag activation, either of which could result in personal injury. Do not touch the individual components directly after the system has been triggered, because there is a danger of burns. ◀

 At all times, occupants should sit upright and be properly restrained – infants and small children in appropriate child-restraint systems; larger children and adults using the safety belts. Never let an occupant's head rest near or on a side airbag because the inflating airbag could cause a serious or fatal injury. Please note that the word "Airbag" imprinted on the door trim panel indicates the airbag's location.

Never install a rear-facing child-restraint device on the front passenger seat. If you do so, the child could be injured when the airbag is triggered.

Children should always ride in the rear and the restraint systems should be secured with the vehicle's belts.

Accident research shows that the safest place for children in an automobile is in the rear seat. However, a child sitting in the rear seat and not properly restrained may place his or her head on or near the airbag, if so equipped.

For example, a child – even though belted – may fall asleep with his or her head against the side airbag. It may be difficult for a driver to ensure that children in the rear seat will remain properly positioned at all times and do not place their heads on or near the side airbag. Therefore, we recommend that the rear side airbags, if provided, be deactivated if you plan to transport children in the rear seat.

The rear seat side airbags may already have been deactivated, either at the time of manufacture or by a BMW center. Labels in the rear door opening should indicate the status of your rear-seat side airbags. If you are uncertain of their status, or wish to have the airbags activated or deactivated, please contact your BMW center. ◀

Even when all these guidelines are observed, there is still a small residual risk of injuries to the face, hands and arms occurring from airbag deployment in isolated instances. The ignition and inflation noise may provoke a mild temporary hearing loss in extremely sensitive individuals.

Airbag warning information is also provided on the sun blinds.

Indicator lamp



The indicator lamp shows the airbag and belt-tensioner system's operational status as soon as you insert the remote control unit in the ignition (radio mode).

System operational:

▷ The indicator lamp comes on briefly.

System malfunction:

▷ The indicator lamp fails to come on or

▷ it remains on continuously.

A system malfunction could prevent the system from responding to an impact occurring within its normal response range. Please respond to any signs of malfunction by having the airbag system inspected immediately at a BMW center.

Transporting children safely

Commercially-available child-restraint systems are designed to be secured with a lap belt or with the lap belt portion of a combination lap/shoulder belt. Improperly or inadequately installed restraint systems can increase the risk of injury to children. Always read and follow the instructions that come with the system.

Child-restraint system with tether strap

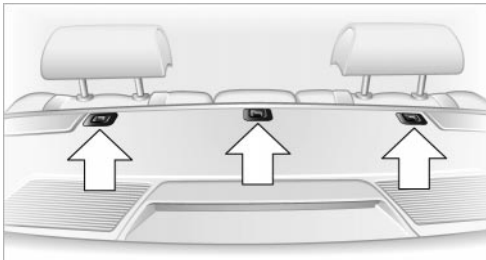

If you use a child-restraint system with a tether strap, three additional tether anchorage points have been provided – refer to the arrows in the illustration. Depending on the location selected for seating in the rear passenger area, attach the tether strap to the corresponding anchorage point to secure the child-restraint system, as shown in the illustration below.

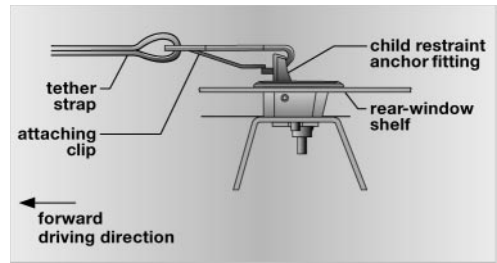

Each seating position is fitted with a head restraint.

Outer seating positions:

Lift the head restraint and pass the tether strap between the headrest and the seat back. It is recommended to readjust the head restraint into the lowest possible position.

Center seating position:

The headrest must be adjusted into the lowest possible position. Pass the tether strap over the headrest.

Adjust the tether strap according to the child-restraint manufacturer's instructions.

⚠ Before installing any child-restraint device or child seat, please read the following:

Never install a rearward-facing child-restraint system in the front passenger seat of this vehicle.

Your vehicle is equipped with an airbag supplemental restraint system for the front passenger. Because the backrest on any rearward-facing child-restraint system – of the kind designed for infants under 1 year and 20 lbs./9 kg – would be within the airbag's deployment range, you should never mount such a device in the front passenger seat, since the impact of the airbag against the child-restraint's backrest could lead to serious or fatal injuries.

If it is necessary for a child – not an infant – to ride in the front seat, certain precautions should be taken. First, move the passenger seat as far away from the instrument panel as possible. This important precaution is intended to maximize the distance between the airbag and the child. Older children should be tightly secured with a

safety belt after they have outgrown a booster seat that is appropriate for their age, height, and weight. Younger children should be secured in an appropriate forward-facing child-restraint system that has first been properly secured with a safety belt. Never install a rearward-facing child-restraint system in the front passenger seat.

We strongly urge you to carefully read and comply with the instructions for installation and use provided by the child-restraint's manufacturer whenever you use such a device.

Be sure that all occupants – of all ages – remain properly and securely restrained at all times. If your vehicle is equipped with electric power seats at the rear, these will need to be returned to their standard adjustment setting position before a child-restraint system is used, refer to page 47. Always press the safety switch for the power windows before transporting children in the rear seats, refer to page 42. This switch also disables the power rear seat adjustment. Incorrect or unsupervised adjustment of the electric power seats could lead to injuries or damage to the child-restraint system(s) installed in the rear. ◀

All rear seating positions in your vehicle meet the recommendations of SAE J1819, an industry recommended practice for securing child-restraint systems in motor vehicles.

Child seat security



All of the rear belt retractors and the front passenger's safety belt can be locked for

mounting and securing child-restraint systems.

Information regarding this is located near the buckle latch of each safety belt.

To lock the belt

Pull the entire length of the belt from the belt retractor. Allow the reel to retract the belt somewhat and engage the buckle, then tighten the belt against the child-restraint system. The retraction mechanism is now locked.

To release the belt

Release the buckle, remove the child-restraint device and allow the belt retractor to reel the belt completely in.

LATCH* child-restraint system

▶ If the vehicle is equipped with electric power seats, these must be returned to their standard adjustment setting before the LATCH child-restraint system can be used, refer to page 47. ◀

LATCH: Lower Anchors and Tethers for Children.

Access to anchorage points

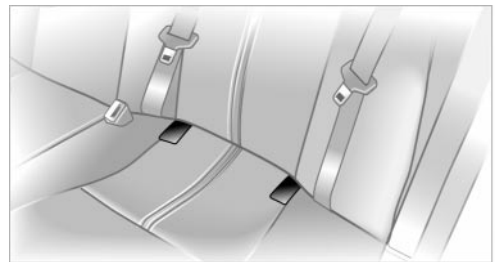

The illustration shows the left rear seat as an example.

The anchorage points for the LATCH child-restraint system are identified by the flags.

Car Memory, Key Memory

How the system functions

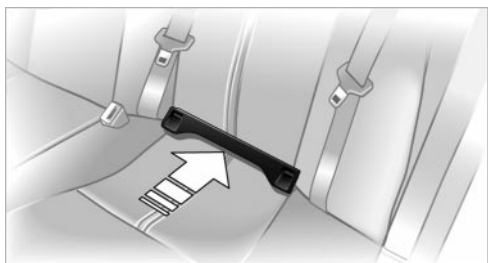

BMW0123CQMA

 You can obtain an installation guide for mounting LATCH child-restraint systems at your BMW center. The guide, although not necessary for installation of a LATCH child-restraint system, will facilitate the installation and also help protect the vehicle's seating surfaces. Always observe all instructions for installation and use provided by the child-restraint's manufacturer. ◀

Engage the buckle on the center belt and then pull the belt away from the child-restraint's anchorage point.

Firmly press the installation guide into the gap between the upholstery on seat and backrest, continuing until the two funnel-shaped guides snap into place in the LATCH support braces in the seat.

Pull the installation guides to remove.

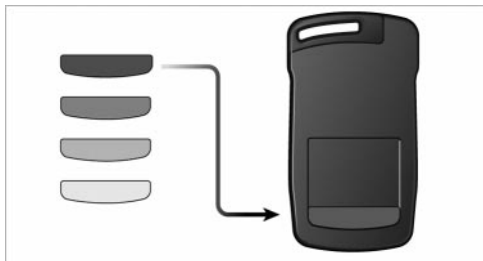

BMW0123CQMA

Doubtless you have often reflected on how great it would be if you could configure your vehicle's various adjustment settings to meet your own personal requirements. In developing your vehicle, BMW has incorporated a number of options for personal adjustment which you can set in the Control Center. You can also have these programmed at your BMW center.

The available configuration settings fall into two categories, according to whether their primary orientation is the vehicle - (Car Memory) - or the individual - (Key Memory). You can have up to four different basic settings adjusted for four different persons. The only requirement is that each person uses his or her own remote control.

When your vehicle is unlocked with the remote control, the vehicle recognizes the individual user by means of a data exchange with the key, and makes adjustments accordingly.

Color-coded decals are provided to help you distinguish the individual remote control units with their different settings.

Child-safety locks



BMW0237CQMA

Slide down the safety levers on the rear doors:

The door can now be opened from the outside only.

What the system can do

Please contact your BMW center for more information on the range of options available with Car Memory and Key Memory.



You will see this symbol throughout the Owner's Manual. It is to remind you at appropriate places of the settings that are available to you. ◀

Examples of Car Memory functions

- ▷ Various confirmation signals when the vehicle's locks are engaged/released
- ▷ Activate/deactivate "Follow me home" lamps function
- ▷ Activate/deactivate daytime driving lamps, e.g., on Canadian models

Examples of Key Memory functions

- ▷ Automatic adjustment of electric power driver's seat
- ▷ Engagement of vehicle locks when the vehicle is set in motion
- ▷ When unlocking, the system disengages the driver's door lock first before proceeding to disengage the remaining vehicle locks.

Ignition lock



MM03210UEA

Insert the remote control unit all the way into the ignition lock. This also activates the radio mode.

▶ When the remote control unit is in the ignition lock you can start the engine without first switching on the ignition. ◀

Switching ignition on and off



MM03211UEA

▶ Do not depress the brake pedal until you are ready to start the engine. If you press the start/stop button while the brake pedal is depressed the engine will start immediately. ◀

Continue to press the start/stop button to switch the radio mode on and off or switch the ignition on and off.

1 Radio mode

In this mode several systems, such as the Control Center, parked-car ventilation, etc., are available for use. The time and

outside temperature appear in the Info Display panel.

▶ The radio mode is automatically deactivated:

▷ after approx. 30 minutes, when a door is closed and the system does not register the presence of any individuals in the vehicle

▷ immediately, when the vehicle is locked from the outside. ◀

2 Ignition on:

All vehicle systems are ready for operation.

0 Ignition off:

The indicator lamps in the Info Display go out. Only the automatic transmission's range display remains visible for a brief period.

To remove the remote control unit from the ignition lock

Press the remote control unit in briefly; it is ejected and now protrudes slightly from the lock. This procedure will also switch off the ignition if it is on.

▶ Switch off the engine before removing the remote control unit from the ignition lock.

The transmission automatically shifts to position P - Interlock. ◀

If the remote control is still in the ignition lock when the driver's door is opened, a gong will sound and a message will appear in the Info Display panel.

Starting the engine

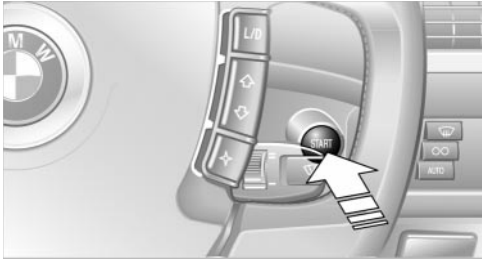

⚠ Do not allow the engine to run in enclosed spaces. The exhaust gases contain carbon monoxide, an odorless and colorless, but highly toxic gas. Breathing the exhaust gases poses an extreme health risk, and can lead to unconsciousness and death.

Never leave the vehicle parked with the engine running, as it would then pose a potential safety hazard. ◀

1. Insert the remote control unit all the way into the ignition lock
2. Depress the brake pedal
3. Maintain pressure on the brake pedal and briefly press the start/stop button.

You can release the brake pedal as soon as the engine starts.

▶ Your BMW is equipped with the convenience starting feature. After depressing the brake pedal, all you need to do is briefly press the start/stop button. The system responds by automatically engaging the starter and allowing it to run until the engine starts, after which it then disengages automatically.

The automatic starting mode will not operate or will be canceled if the battery voltage is low. It is then possible to start the engine using electrical power from an outside source, refer to page 187.

The engine starts immediately in response to pressure on the button at speeds of roughly 3 mph (5 km/h) and above. It is not necessary to depress the brake pedal. ◀

Do not allow the engine to warm up by leaving it running while the vehicle remains

stationary. Instead, begin to drive immediately at a moderate engine speed.

Under the following conditions you should press the accelerator pedal halfway down when starting:

- ▷ If the engine fails to start on the first attempt, for instance, if it is very hot or cold
- ▷ During cold starts at high altitudes, of roughly 3,300 ft (1000 m) and above, and in extreme cold, at temperatures of approximately +5 °F (-15 °C) and below.

⚠ Refrain from starting the vehicle repeatedly at brief intervals, and avoid an excessive number of starting attempts if the vehicle fails to start; repeated activation of the starter over an extended period would allow unburned or only partially combusted fuel to enter the catalytic converter, where it can cause overheating and damage to the unit. ◀

Switching off engine

With the vehicle stationary, briefly press the start/stop button. This also activates the radio mode.

▶ Should exceptional circumstances render it necessary for you to switch off the engine while the vehicle is moving, maintain pressure on the start/stop button for approx. 1 second.

If you maintain pressure on the start/stop button for longer than two seconds while switching off the ignition, the remote control unit will be ejected. ◀

⚠ Always remove the remote control unit from the ignition lock before leaving the vehicle. ◀

Parking brake

The concept

Your BMW is equipped with an electro-mechanical parking brake.

The parking brake is primarily intended to prevent the vehicle from rolling while parked.

You have two separate options for engaging the parking brake:

- ▷ Manually, by briefly pressing the button
- ▷ Automatically, through activation of the Automatic Hold mode, refer to next column.

An electrohydraulic mechanism then engages the parking brakes to prevent the rear wheels from turning whenever you switch off the engine.

When the engine is running, parking brake engagement is controlled by the brake system's hydraulic circuits, which act on the disc brakes at the front and rear wheels.

Brake pedal feel

Because this function is activated using the brake system's hydraulic circuits, the response of the brake pedal may change slightly. Engagement may also be accompanied by activation noise – this is normal.

Manual engagement



Press the button briefly, the word "PARK" appears briefly in the Info Display.

The (P) indicator lamp appears in red in the Info

Display when the parking brake is engaged, refer to page 14.

- ▷ The indicator lamp (P) goes out soon after you switch off the ignition. ◀

Manual release



With the ignition on, briefly press the button: the indicator lamp in the Info Display goes out.

- ▷ Provided that the detent holding the remote control unit in the ignition lock is engaged, you can also release the parking brake after the engine has been switched off. This function is intended for use in automatic car washes, etc. ◀

⚠ When leaving the vehicle, always release the remote control unit from the detent in the ignition lock; this precaution prevents children from disengaging the parking brake, etc.

The parking brake can still be engaged at any time when the remote control unit is released from the detent. It is only possible to disengage the parking brake with the ignition on. ◀

⚠ If exceptional circumstances should make it necessary to engage the parking brake while the vehicle is in motion, maintain pressure on the button. The indicator lamp appears in red in the Info Display. A gong sounds at the same time.

The brake lamps come on.

The vehicle continues to brake automatically for as long as you maintain pressure on the button. ◀

- ▷ When you brake the vehicle to a virtual stop, i.e., down to a speed of approx. 1.9 mph (3 km/h) or below, the parking brake remains engaged. The indicator lamp (P) in the Info Display appears in red. Press the button briefly to disengage the parking brake manually. ◀

Automatic Hold

You can activate this feature after starting the engine; it then remains operational until the next time the engine is switched off.

This feature provides supplementary support during vehicle operation by automatically engaging and releasing the parking brake during stops at traffic lights,

in stop-and-go traffic, etc. As the vehicle then no longer tends to "creep" when a driving position is engaged, it is no longer necessary to hold the vehicle by depressing the brake pedal.

It prevents the vehicle from rolling backward during uphill starts.

The parking brake also engages automatically when you switch off the engine after stopping the vehicle.

You can activate and deactivate the Automatic Hold feature by selecting the "Settings" menu in the Control Center. A description of the Control Center is provided on page 19.

Automatic Hold activation/deactivation

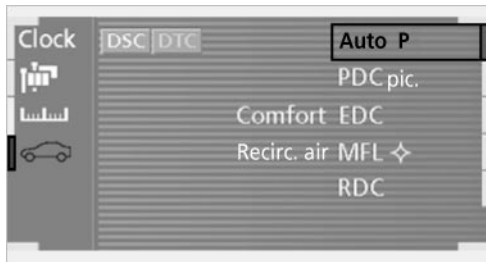

1. Select the "Settings" menu
2.  Confirm your selection
3. Select "Auto P." Press the controller to activate/deactivate the desired function.

▷ Automatic Hold is activated.

The green "Auto P" status message in the Info Display shows you that the system is ready for operation.

▷ Automatic Hold is deactivated.

The green "Auto P" message disappears from the Info Display panel.

 You can program the programmable function button on the steering wheel to control the Automatic Hold function, refer to page 53.

This will allow you to activate and deactivate the Automatic Hold function quickly and without distraction from traffic and road conditions. ◀



You can also deactivate Automatic Hold by pressing the button while the vehicle is stationary. The vehicle remains stationary, the indicator lamp changes from green to red. Press the button again to release the parking brake.

Driving with Automatic Hold

The parking brake engages automatically when the vehicle comes to a stop. The indicator lamp  in the Info Display appears in green.

To start off again, simply depress the accelerator pedal. The parking brake disengages automatically, and the indicator lamp  goes out.

 Do not drive through an automatic car wash with the Automatic Hold on and the engine running. The system would engage the parking brake while the vehicle is stationary. ◀

Parking with Automatic Hold

The parking brake engages automatically when you stop the vehicle and switch off the engine. The indicator lamp  changes from green to red.

 Provided that the remote control unit is engaged in the ignition lock, you can also release the parking brake manually after switching off the engine, refer to page 63. This option is useful in automatic car washes, etc.

Automatic Hold is deactivated. ◀

 When leaving the vehicle, always release the remote control unit from the detent in the ignition lock; this precaution prevents children from disengaging the parking brake, etc. ◀

For your safety

Automatic Hold is automatically deactivated when

- ▷ the engine is switched off
- ▷ the system determines that the driver's seat is not occupied while the engine is running

- ▷ the hood is opened while the engine is running
- ▷ the luggage compartment is opened with the transmission in reverse while the engine is running, and
- ▷ when the parking brake is used to bring the vehicle to a stop.

The indicator lamp (P) shifts from green to red, and the "Auto P" message disappears from the Info Display.

Before starting off again, briefly press the button to disengage the parking brake manually, refer to page 63, or reactivate Automatic Hold, refer to page 64.

 Before leaving the vehicle with the engine running, always move the automatic transmission's selector lever to position P and ensure that the parking brake is engaged. The vehicle could start to roll if you fail to observe these precautions. Never leave an unattended vehicle with the engine running, as such a vehicle represents a potential safety hazard. ◀

 Automatic Hold is automatically deactivated whenever the system detects any tendency for the wheels to spin in response to slippery road surfaces. Note the status displays in the Check Control panel. You can find more detailed information on Check Control on page 80. ◀

Malfunctions

In the event of malfunction, the indicator lamp (P) in the Info Display will light up yellow, and a status report will appear in the Check Control panel. Please remember to observe the supplementary information provided in the Control Display.

To disengage the parking brake manually

You can respond to any interruptions in the supply of electrical power, for instance, if the battery is discharged or disconnected, by releasing the parking brake manually.

 Before proceeding to release the parking brake manually, and each time you park the vehicle without engaging

the parking brake, always ensure that the automatic transmission's selector lever is in position P, refer to page 66. Note the range indicated in the Info Display. If it is not possible to avoid parking on an extremely steep slope, use some supplementary means, such as a wheel chock, to make certain that the vehicle will not roll, refer to page 184. Otherwise the danger exists that the vehicle could roll when parked on a very steep hill. ◀

Should it be necessary to release the automatic transmission's lockout manually, for instance, if the battery is discharged, always adhere to the following sequence:

1. If necessary, start by manually releasing the parking brake
2. Then release the automatic transmission's lockout manually, refer to page 70.

Towing and jump-starting, refer to pages 187 and 188.

What you will need

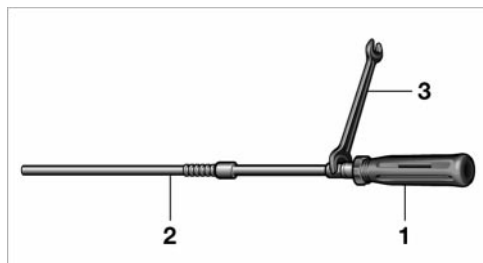

- 1 Screwdriver handle
- 2 Emergency-release tool
- 3 10 mm open-end wrench

You will find the required tools in the tool kit mounted on the inside of the luggage compartment lid, refer to page 181.

Insert the emergency-release tool in the screwdriver handle as shown in the illustration.

To release

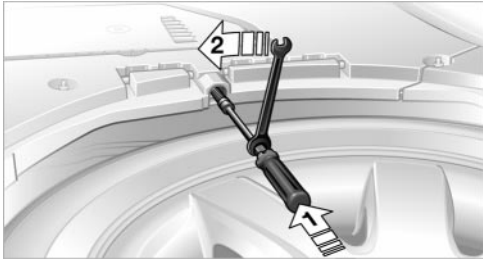



MAY0110403AAA

1. Remove the floor mat and the cover on the spare tire
2. Guide the emergency-release tool with the screwdriver handle into the opening, arrow 1
3. Apply the open-end wrench to the hexagon on the emergency-release tool. Press against the resistance from the spring to guide the emergency-release tool all the way in, then hold it in place. Turn the emergency-release tool in the direction indicated by the arrow 2, continuing until you hear the mechanism snap into place and feel resistance; maintain pressure on the tool after the mechanism engages
4. Use the open-end wrench to turn the emergency-release tool against the drive unit's mechanical resistance, continuing to rotate it in arrow direction 2 until you feel a substantial increase in turning effort.

 To prevent possible damage to the rear brakes, always make sure that the parking brake is completely released before driving the vehicle. ◀

5. Return the tools to their places
6. Return the spare tire cover and the floor mat to their original locations.

 Have any defects repaired at the nearest BMW center. The technicians can also return the parking brake to normal operational status after it has been released manually in response to malfunction. ◀

 Following manual release, the actual status of the parking brake may vary from that displayed by the indicator lamp. ◀

Operation after interruptions in power supply

 The parking brake may only be used again, if it is released manually after an interruption in power supply, i.e. as a result of a discharged or disconnected battery. If this is not done, the parking brake may fail to operate correctly. Even with the parking brake engaged, there would be a danger of the vehicle rolling on steep hills. ◀

Once the electrical power supply has been restored you can again use the parking brake:



With the ignition on and the vehicle stationary, tap the button three times at intervals of approx. 5 seconds. This initializes the system as follows:

- ▷ Initializing the disengaged setting
- ▷ Engage – the system registers the new status and the brake setting is initialized. The indicator lamp (P) in the Info Display appears in red
- ▷ Release – the parking brake is ready for operation. The indicator lamp (P) in the Info Display goes out.

Automatic transmission with L mode

While you can drive as with a conventional automatic transmission, you also have the option of retaining your current gear selection with the L/D button on the steering wheel, refer to page 68.

Transmission ranges



MAY01214UEA

Program display

L1 - L6

Buttons on steering wheel

L/D -

Selecting transmission range

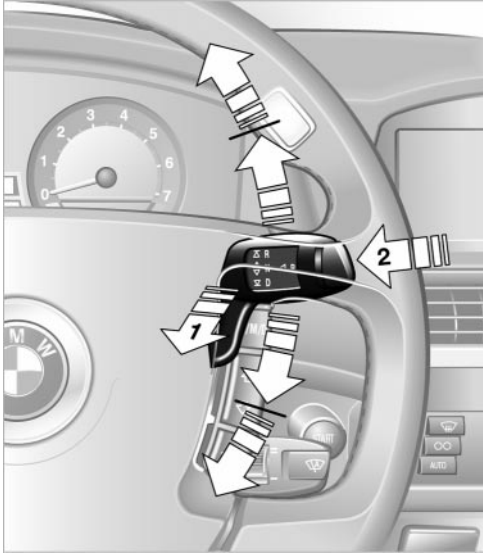

 The selector lever is at the center position. To select transmission ranges D, R or N, always start by pulling toward the steering wheel, arrow 1, then press up or down. Note the range indicated in the Info Display. ◀

▷ Range D or R:

Press the selector lever up or down, continuing to apply pressure to move it past the detent

▷ Neutral N:

Press the selector lever as far as, but not beyond, the detent (resistance)

▷ Park P:

Press button P, arrow 2.

The selector lever immediately returns to the center position when released.

 Depress the brake pedal before shifting out of P or N; the shift

command will not be executed unless the brake is applied - Shiftlock.

To prevent the vehicle from creeping after you select a range, maintain pressure on the brake pedal until you are ready to start. You can activate the Automatic Hold feature to suppress the vehicle's tendency to creep when a driving position is engaged at idle, refer to page 63. ◀

Shift commands are transmitted electronically. To help avoid malfunctions, each command undergoes a plausibility check prior to execution.

Remember to observe the Check Control for status messages.

You can find additional information on the Check Control on page 80.

 To prevent the vehicle from rolling, always select position P and engage the parking brake before leaving the vehicle with the engine running. Note the information provided in the Info Display. Never leave an unattended vehicle with the engine running, as such a vehicle represents a potential safety hazard. ◀

P - Park

 Press the button. Select only when the vehicle is stationary. The transmission lockout prevents the rear wheels from turning. The lockout disengages when you press the selector lever toward D, N or R while the engine is running.

 P is automatically engaged when you remove the remote control unit from the ignition lock after parking the vehicle. ◀

R - Reverse

 Press the selector lever upward, continuing to apply pressure to move it past the detent. Select R only when the vehicle is completely stopped.

N Neutral - Neutral

 Press the selector lever as far as the detent, but no further. Select N only if your journey is interrupted for a long period.

▷ From D press the selector lever up

▷ From R press the selector lever down. Note the arrows indicating direction in the range display.

▷ N is selected automatically whenever the remote control unit remains locked in the ignition lock after the ignition is switched off. This function is useful in automatic car washes, etc. After approx. 30 minutes the system automatically engages P. Remember to observe the Check Control for status messages. ◀

D Drive – Automatic

▷ D Press the selector lever down, continuing to apply pressure to move it past the detent. This is the range recommended for normal vehicle operation. All forward gears are available.

Kickdown

The kickdown mode provides maximum acceleration. Press the accelerator pedal beyond full-throttle detent point.

L mode

We recommend the L mode for times when you wish to suppress certain shifts, for instance, when ascending or descending steep grades.



When the L mode is activated the transmission remains in your current gear, which also appears in the Info Display, refer to page 67. The transmission continues to shift through the available ratios, but does not proceed beyond the gear in the display.

To activate the L mode

Press the L/D button on the steering wheel. The transmission downshifts when you tap the buttons on the rim of the steering wheel. The newly selected limit appears in the Info Display.

The transmission only executes downshifts that will result in a plausible combination of vehicle and engine speeds. The transmission will no longer execute upshifts beyond the selected range.

▷ Deactivate the L mode to obtain maximum acceleration for overtaking maneuvers, etc. ◀

To deactivate the L mode

- ▷ Press the L/D button or
- ▷ press the selector lever into position D once again.

Automatic transmission with Steptronic

Canadian models only

While you can drive as with any conventional automatic transmission, you also enjoy the option of shifting manually at the steering wheel, refer to the next column.

Transmission ranges



P R N D

Program display

S or M1 – M6

Buttons on steering wheel

S/M/D + –

To select a transmission range

The procedure for selecting transmission ranges is the same as that employed in the L mode, refer to page 67.

Sport program and manual operation



When you press the S/M/D button on the steering wheel once, the system responds by activating the transmission's Sport program, as indicated by the letter S in the Info Display, refer to previous column. We recommend this program for performance-oriented driving.

When you press the S/M/D button a second time the transmission switches to its manual mode; press again to return to the automatic program.

You can also return to the standard automatic program by reselecting D.

In the manual mode the transmission upshifts when you briefly tap the buttons on the rear of the steering wheel. You downshift by briefly pressing the buttons on the front of the steering wheel. The Info Display shows the manual ranges M1 through M6.

Upshifts and downshifts are executed only when they will result in a plausible combination of engine and vehicle speed; thus (for example) a downshift that would cause the engine to overrev will not be executed by the system. The selected gear appears briefly in the Info Display, followed by the current gear.

 To obtain maximum acceleration (for passing maneuvers, etc.) during operation in the manual mode, use the kickdown or downshift manually. ◀

Malfuncions

A status message will appear in the Check Control panel to alert you to any malfunctions in the transmission-control system. Please note any supplementary information that appears in the Control Display. The directional arrows also start to flash in the Info Display.

While it will remain still possible to move the selector lever to any desired position, the transmission will revert to operation in its default mode with only a limited number of forward gears.

Some types of malfunction will make it impossible to engage all gears.

The engine may respond with reduced output when accelerating from a standing start.

If this happens, avoid extreme engine loads and consult the nearest BMW center.

 If no status messages appear in the Info Display you should accelerate carefully to confirm that you are driving in the desired direction.

Never work in the engine compartment with any of the forward or reverse gears engaged, as the vehicle could start to move. Engage the parking brake, refer to page 62. ◀

Manual release of transmission lockout

You can respond to any interruptions in the supply of electrical power, for instance, if the battery is discharged or disconnected, by releasing the transmission lockout manually.

 To prevent the drive wheels from locking up and sliding, the transmission lockout must always be released manually before the vehicle is towed. ◀

 Press the brake pedal before releasing the transmission lockout

manually. If the brakes are not applied, the vehicle could start to roll if parked on a steep slope.

The transmission lockout should only be released for towing. Remember to engage the transmission lockout when you repair the vehicle after moving it.

Should it also be necessary to release the parking brake manually (owing to a discharged battery, etc.), always adhere to the following sequence:

1. Start by manually releasing the parking brake, refer to page 65
2. Then proceed to manually release the transmission lockout. ◀

Jump-starting and towing, refer to pages 187 and 188.

To release

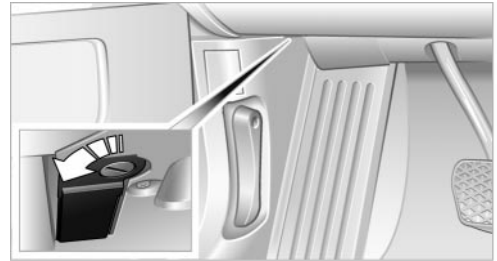

1. Use the vehicle key to release the cover panel beneath the instrument panel by turning the lock counterclockwise, then fold down the cover

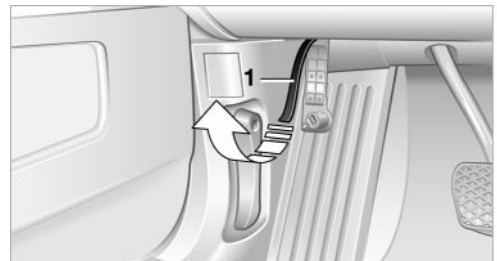

2. Use the strap 1 to pull out the release lever, continuing until it snaps into place – the transmission lockout is released.

 Re-engage the transmission lockout after parking the vehicle at its destination. Otherwise there is a danger that the

vehicle could start to roll if parked on a steep slope. ◀

To re-engage the lockout



1. Disengage the release lever by pressing it together with the red detent lever, arrow 1
2. Guide the release lever all the way back into its original position – the transmission lockout is again engaged
3. Fold up and lock the cover panel. Now – and not before – the key may be removed.

! Once the transmission lockout has been re-engaged, the warning in the Check Control should disappear, and the symbol in the Info Display should change from N to P. Should this fail to happen, there is a danger that the vehicle could start to roll. ◀

Information on jump-starting, tow-starting and towing begins on page 187.

Turn signal indicators/ headlamp flasher

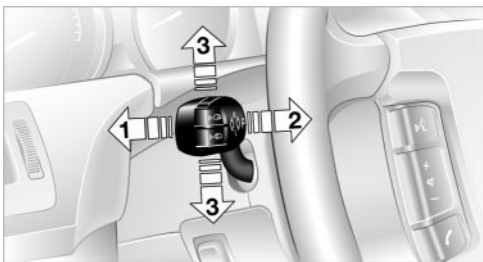

- 1 High beams – blue indicator lamp
- 2 Headlamp flasher – blue indicator lamp

3 Turn signal indicators – the green indicator lamp flashes, accompanied by a periodic ticking from the turn signal indicator relay.

To use the turn signal indicators

Move the lever beyond the detent position. It then returns to the center position when released. Press the lever as far as the detent to switch off the turn signals.

To signal briefly

Press the lever up to but not beyond the detent. It then returns to the center position when released.

If the flashing of the indicator lamp and the ticking from the relay are both faster than normal, this indicates that one of the bulbs is defective; if a trailer is attached, this could also indicate that one of its turn signal indicator bulbs is defective.

Wiper system

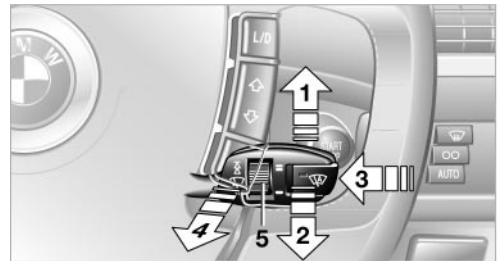

- 1 Standard wiper speed: press briefly one time.
Fast wipe: briefly press twice
- 2 To switch off wipers or for brief wipe
- 3 To activate/deactivate rain sensor
- 4 Cleaning windshield
- 5 Adjusting rain sensor sensitivity level.

▷ The lever automatically returns to its initial position when released. ◀

1 Standard wiper speed

The system automatically reverts to operation in the intermittent mode whenever the vehicle stops.

Fast wiper speed

You can also select this position by pressing the lever upward past the detent.

The system automatically reverts to operation in the standard wipe mode whenever the vehicle stops.

4 Clean windshield

The system sprays washer fluid against the windshield and activates the wipers for a brief period.

Cleaning headlamps

▷ Each fifth time you press into position 4 to wash the windshield while the headlamps are on.

 Do not use the washers if there is any danger that the fluid will freeze on the windshield. If you do so, your vision could be obscured. To avoid freezing, use a washer fluid antifreeze, refer to page 73. Avoid activating the washer when the reservoir is empty, as damage to the pump could result. ◀

Windshield washer nozzles

The windshield washer nozzles and the windshield itself in the area around the wipers are heated automatically when the ignition is switched on.

Rain sensor

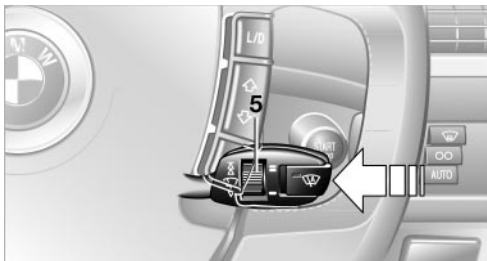

The rain sensor is located on the windshield, directly in front of the interior rear-view mirror.

To activate the rain sensor

Press briefly with ignition in radio mode, refer to arrow. The indicator lamp comes on. The wipers will always respond by completing at least one sweep of the windshield.

Adjusting rain sensor sensitivity level

Turn the rotary knob 5.

To deactivate the rain sensor

Press the button again. The indicator lamp goes out.

 The rain sensor is automatically deactivated when you switch off the ignition. ◀

 Deactivate the rain sensor when passing through an automatic car wash. Failure to do so could result in damage caused by undesired wiper activation. ◀

Selecting wiper fold-out position

Important for changing wiper blades, when folding away from windshield to prevent blades from sticking when ice forms, etc.

1. Switch off the engine and remove the remote control unit from the ignition lock
2. Press the wiper lever up and maintain pressure for about 3 seconds, continuing until the wipers are roughly vertical – this is the fold-out position.

After folding the wipers back against the windshield you will need to reactivate the wiper system:

1. Insert the remote control unit to activate the radio mode in the ignition lock
2. Apply brief upward pressure to the wiper lever. The wipers return to their retracted position and are ready for normal operation.

 To prevent damage to the wipers, always fold them back against the

windshield before switching on either the radio mode or the ignition. ◀

Washer fluid

Windshield and headlamp washers

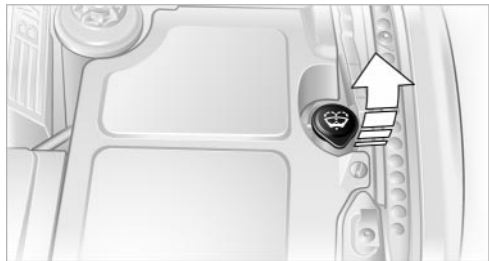

Capacity: approx. 8.2 quarts (7.8 liters)

Fill with water and – if required – with a washer antifreeze (according to manufacturer's recommendations).

 We recommend that you mix the washer fluid before adding it to the reservoir. ◀

 Windshield washer antifreeze is flammable. Always keep it well away from sparks and open flames, and store it in tightly closed containers well out of the reach of children. Always observe the instructions for use provided on the container. ◀

Programmable cruise control

The concept

The programmable cruise control is available for use at speeds of approx. 18 mph (30 km/h) and higher. The vehicle maintains and stores the speed that you set using the lever mounted on the steering column.

You can also use the multilevel preset mode to store 6 speeds for later selection with the lever on the steering column, refer to page 75.

This feature assists you in quickly adapting vehicle speed to specific road conditions, for instance, changes in speed limits.

One multilevel lever

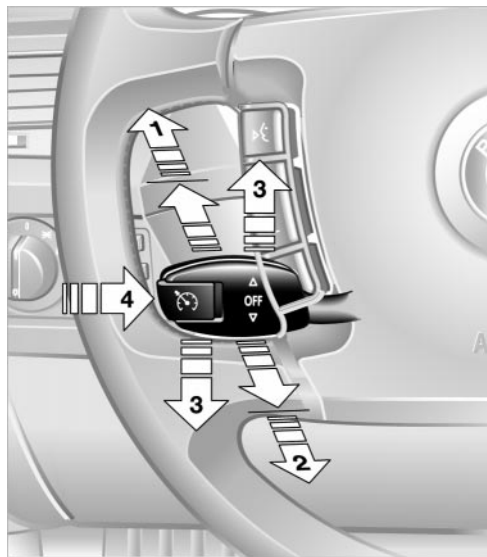

Cruise control

1 Press the lever as far as the detent:

- ▷ To activate cruise control
- ▷ Maintain and store speed
- ▷ To accelerate

2 Pull lever back to detent:

- ▷ To activate cruise control
- ▷ Maintain and store speed
- ▷ To decelerate

3 Briefly tap lever up or down:

- ▷ To interrupt the cruise control

4 Press button briefly:

- ▷ To recall a stored speed.

Multilevel preset mode

1 Press the lever beyond the detent:

- ▷ Activating multilevel preset mode, refer to page 75
- ▷ To select the next higher desired speed



2 Pull the lever back beyond the detent:

- ▷ Activating multilevel preset mode, refer to page 75
- ▷ To select the next desired speed

- 3** Briefly tap lever up or down:
 - ▷ To interrupt the cruise control
- 3** Maintain pressure on lever for approx. 3 seconds:
 - ▷ To cancel display of multilevel preset mode in speedometer.
-  Press **1** or pull **2** the lever beyond the detent to reactivate the display for the multilevel preset mode. ◀
- 4** Press button briefly:
 - ▷ Select stored speed
- 4** Maintain pressure on button for approx. 3 seconds:
 - ▷ To store and delete speed settings, refer to page **75**.

Display screen contents



- 5** Preset speed display
 - ▷  - Cruise control activated
 - ▷  - Cruise control deactivated
- 6** Stored desired speed display – multilevel preset mode
 -  **5** and **6** appear in the display when the system is active. ◀

To activate cruise control

Press **1** or pull **2** lever as far as the detent. You can now use the cruise control. The system simultaneously maintains and stores the current speed.

 Do not use the cruise control on twisting, curving roads, when high traffic density prevents travel at a constant speed, or when driving on slippery roads – snow, rain, ice – or loose surfaces – rocks, sand. ◀

1 Maintain and store speed, accelerate

Press lever forward as far as but not beyond the detent: The system maintains and stores the current vehicle speed. Every time you tap the lever the vehicle's speed increases by roughly 0.6 mph (1 km/h).

Maintain pressure on the lever: The vehicle accelerates without pressure on the accelerator pedal. The system maintains and stores your current speed as soon as you release the lever.

 The vehicle may accelerate beyond the preset speed on steep downhill stretches where the engine's braking effect alone may not be sufficient to slow the vehicle. Speed can drop on uphill grades if the engine output is insufficient. ◀

2 Maintain and store speed, decelerate

Pull the lever back, as far as but not beyond the detent: The system maintains and stores the current vehicle speed. Each time you tap the lever the vehicle will decelerate by approx. 0.6 mph (1 km/h).

Pull lever back and hold: The throttle aperture is automatically reduced, slowing the vehicle. The system maintains and stores your current speed as soon as you release the lever.

3 Interrupt cruise control

Briefly press the lever up or down while the cruise control is active. The status message 5 in the Info Display is no longer highlighted. You can use the cruise control again as required.

In addition, cruise control is interrupted automatically

- ▷ When you apply pressure to the brake pedal
- ▷ when you select the automatic transmission's neutral range N
- ▷ when the DSC (Dynamic Stability Control) system is in active operation.

4 To recall stored speed

Briefly press button 4: The vehicle accelerates to and maintains the last speed stored.

To deactivate the cruise control

The stored speed is deleted from the system memory when you switch off the ignition.

To activate multilevel preset mode

Push 1 or pull 2 the lever beyond the detent.

The system maintains and stores the current speed, which is also displayed as a preset speed 5 and as the desired speed 6.

 If no levels are programmed, with the graduated function in operation you can push or pull the lever past the detent to increase or decrease the vehicle's speed in increments of 6.2 mph (10 km/h). ◀

1 Change preset level

Press 1 or pull 2 the lever beyond the detent: The preset speed progresses to the next desired speed. The lowest desired speed that it is possible to select is roughly 18 mph (30 km/h).

3 Interrupt cruise control

With the cruise control active, briefly tap the lever up or down.

To deactivate the multilevel preset mode

The multilevel preset mode is deactivated when you switch off the ignition.

Multilevel preset mode – Storing speeds

With vehicle stationary



Switch on the ignition.

Press 1 or pull 2 the lever past the detent: The displays 5 and 6 appear; 5 indicates the available preset speed.

- ▷ To increase speed: Press the lever forward
- ▷ To decrease speed: Pull back the lever
- ▷ To store speed:

Maintain pressure on the button 4 for approx. 3 seconds. The stored preset desired appears in 6.

 If 6 speeds have already been stored, it will be necessary to delete one before entering a new preset speed. ◀

While driving

Activate multilevel preset mode.

Maintain pressure on button **4** for approx. 3 seconds. The system adopts and displays your current speed as a preset speed.



If all of the graduations flash at once this indicates that 6 speeds have already been stored. You must then delete at least one. ◀

To delete preset speeds

Select the desired preset speed **5**.

Maintain pressure on button **4** for approx. 3 seconds. The desired preset speed is deleted.

Everything under control

Odometer, outside temperature display, clock



When the ignition is off you can briefly activate the time, outside temperature and odometer displays by pressing the knob at the upper left of the Info Display.

1 Outside temperature display, clock

The outside temperature and the time displays are active starting at the radio position in the ignition lock.

You can change the units of measure – °C/°F – in the "Settings" menu, refer to page 86.

Setting the clock, refer to page 86.

Ice warning

A warning signal sounds when the outside temperature falls to roughly +37.5 °F (+3 °C); this is accompanied by a message in the Check Control display.

 Please bear in mind that the ice warning does nothing to alter the fact that glare ice may be present on roads at temperatures higher than +37.5 °F (+3 °C), for instance, on bridges and shade-covered surfaces. ◀

2 Odometer

The odometer panel also provides displays for the computer and the Check Control.

Regardless of the current display mode, you can view the odometer reading for a short period by pressing the knob at the upper left of the Info Display.

Check Control, refer to page 80.
Computer, refer to page 81.

3 Trip odometer

The trip odometer must be present in the display before you can reset it to zero. Reset by pressing the knob at the upper left of the Info Display.

Tachometer



The orange warning sector (see arrow) gradually moves upward as the engine

warms to its normal operating temperature. The segments disappear in sequence as the engine warms to its normal operating temperature.

Avoid allowing the engine speed to rise as far as the orange warning sector whenever possible.

Service Interval Display

Info Display screen contents

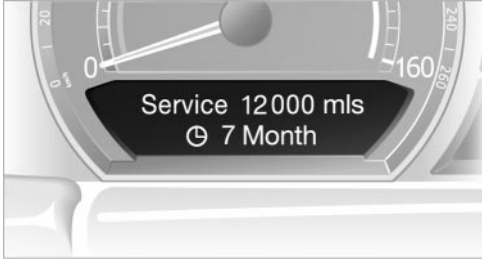

The distance/period remaining until your next service briefly appears when you switch on the ignition.

 The Info Display immediately switches to its computer mode when you press one of the two buttons in the turn signal indicator lever, refer to page 81. ◀

Control Display screen contents



You can view additional information on service and maintenance procedures by selecting the "OB data" menu.

1.  Select and confirm

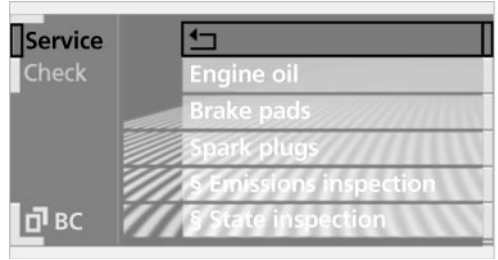

2. Select "Service" and confirm your entry

3. The display shows a list of selected service and maintenance procedures, as well as legally-mandated official inspections.

Red sectors

The service deadline has already passed.

Yellow sectors

The deadline for service or an official inspection is approaching. Please contact your BMW center for an appointment.

Green lamps

No service is currently required. If you desire, certain maintenance operations can be carried out at the next service at the customer's request.

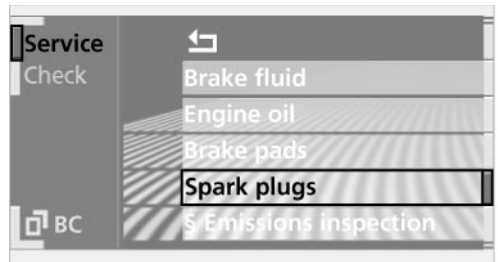



You can request more detailed information on every entry.

Turn the controller to scroll through the list, then confirm the selected entry.

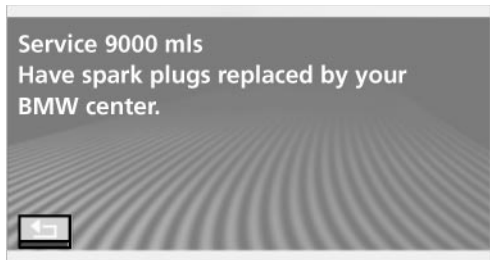
 Confirm to exit the list.



The display will automatically go out after a short period; you can also cancel the display manually using the  symbol.

 The Service Interval Display does not continue counting down to the next service during periods when the vehicle is stored with the battery disconnected or the battery switch OFF.

Please remember that brake fluid should be changed every two years at the latest, even if the display does not yet indicate that service is required, for additional information refer to page 178.

This same precaution applies to all of the other service and maintenance operations scheduled according to periodic intervals. ◀

To enter and view deadlines for official emissions and vehicle inspections

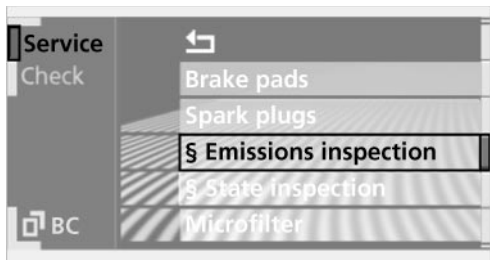

1. Select "\$ Emissions inspection" or "\$ State inspection" and confirm your selection
2. Turn the controller to select an inspection date for entry



3. Confirm the inspection date. The first part of the date entry is activated – here month.

- ▷ Turn to reset
 - ▷ Press to store and move to the next entry – here year.
- The system adopts the date when you store your entry.

4. Press the controller to select "CONFIRM."

 This function is only available if the time in the Control Display has been correctly set, refer to page 86. ◀

Info Display screen contents

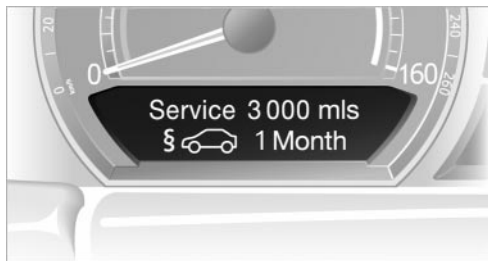

If the deadline for your next emissions or state vehicle inspection is approaching, the remaining distance and time will appear briefly when you switch on the ignition.

 Your Service Advisor will determine your vehicle's current service requirements by reading out the data stored in the vehicle's key. ◀

Check Control

Info Display screen contents



Messages and status reports appear in text form accompanied by an indicator lamp symbol. The alert is accompanied by a gong.

Status reports warning of system malfunctions are assigned one of two priority ratings:

Priority 1:

These status messages and malfunction reports are signaled by a gong. Simultaneous defects will be displayed consecutively. These messages cannot be deleted, and they remain in the display until the problem is corrected. Supplementary information also appears in the Control Display, refer to Automatic messages in Control Display.

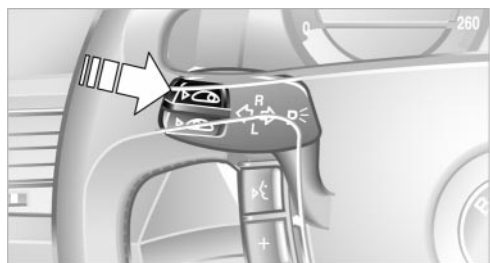

Priority 2:

These status messages and malfunction reports appear in the Info Display for approx. 20 seconds.

Briefly press the CHECK button on the turn signal indicator lever (see arrow) to cancel

the message in the display (if allowed by priority rating).

 You can select stored status reports for viewing in the Control Display, refer to Selecting stored status reports for viewing in the Control Display. ◀

Check Control symbol and messages in the Control Display

The status of the monitored system is indicated by the color of the Check Control symbol  .

Green

No malfunctions are present in the monitored systems.

Yellow or red

A defect or malfunction has been detected in the monitored system. Depending upon how serious the problem is, a supplementary message may also appear in the Control Display.

You can access the stored status reports through the Control Display, refer to the next column.

 The symbol also indicates the status of the Service Interval Display, refer to page 25. ◀

Automatic messages in Control Display

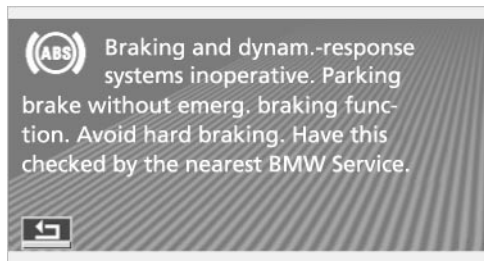

These supplementary messages are intended to assist you in assessing the severity of malfunctions; they provide you with the information you need to decide on the best way to respond.

 Select and confirm to cancel the display.

Selecting stored status reports for viewing in the Control Display



1. Select the "OB data" menu
2.  Select and confirm your selection

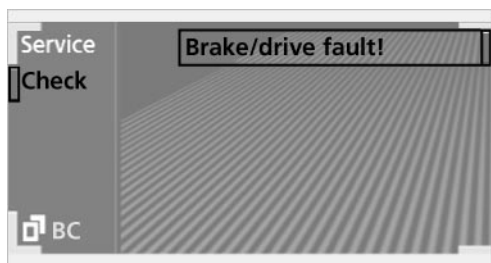

3. Select "Check" and confirm
4. The stored status reports appear in the display. Select the desired report and confirm your selection.

The display will disappear automatically after a short period; you can also cancel it manually using the  symbol.

Displays after completion of trip

Selected malfunction reports generated during the trip are shown consecutively when you switch off the ignition.

If indicated, the following message may also appear:

"Parking lamps on!"

This message appears when you open the driver's door after parking. A supplementary gong is also heard.

Even with the ignition and Info Display off, you can reactivate the screen and display the messages.

Press the CHECK button for approx. 8 seconds, refer to page 80. The stored status reports appear again in the display. If several messages are present, you can continue to press the CHECK button to view them in succession.

The Check Control function

- ▷ cancels itself automatically after a brief period
- ▷ can be terminated by again pressing the CHECK button for approx. 8 seconds.



You can select the language in which Check Control status reports and messages from the computer will appear, refer to page 86. ◀

Computer

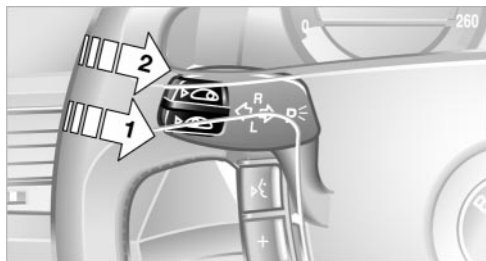

To select functions:

You can use the buttons in the turn signal indicator lever to request a display from the computer on the Info Display screen, starting at the radio position in the ignition lock.

- 1 Info Display on left
- 2 Info Display on right

A new function appears each time you press the button.

Info Display screen contents



MM012281UEA

The display sequence:

- ▷ Fuel gauge, see next column
- ▷ Cruising range and remaining distance to destination [83](#).



MM012191UEA

The display sequence:

- ▷ Odometer [77](#)

- ▷ Energy Control/ Current fuel consumption [83](#)
- ▷ Average fuel consumption [83](#)
- ▷ Average speed [83](#)
- ▷ Time of arrival [83](#).

▷ Maintain pressure on the button [1](#) to cancel the display from the computer. Press the button again to return to the last display.

It will not be possible to cancel the display if the fuel level has fallen into the reserve range or if a Check Control status report is currently on the screen.

Press the button again to view the last display. ◀

Fuel level display

The fuel gauge mode appears automatically once the fuel level falls into the reserve range. The word "Reserve" appears at the same time, indicating that approx. 2.6 gallons (10 litres) of fuel remain in the fuel tank.

▷ It will not be possible to cancel the onboard computer display once the fuel level drops into the reserve range. However, you can still request a display of the cruising range. Computer, refer to page [81](#). ◀

Tank capacity: approx. 19.4 gallons (88 litres).

If the tilt of the vehicle varies (when you are driving in mountainous areas, for example), the needle may fluctuate slightly.

⚠ Always remember to refuel early: attempts to continue driving to the last drop can result in damage to the engine and/or catalytic converter. ◀

Cruising range

Displays the estimated cruising range available with the remaining fuel. The system calculates the cruising range based on operating conditions and the amount of fuel remaining in the tank. The basis for the calculations is the average fuel consumption over the preceding 20 miles (30 km).

To avoid serious damage to the engine or catalytic converter, always refuel as soon as possible once your cruising range falls to below 30 miles (50 kilometers).

When refueling you must add at least approx. 1 1/3 gallons (5 litres) before the computer will register the additional fuel.

Distance to destination

When you enter a destination in the navigation system or manually enter a distance in the computer prior to departure, the system can also display the distance remaining to your destination, refer to pages 126 and 84.

The system automatically adopts the distance to your destination using the route recommended by the navigation system.

 When you enter a destination in the navigation system, any manual entries will be overwritten no later than once 1640 feet (500 meters) of the calculated distance have elapsed. ◀

Energy Control/ Current fuel consumption

Shows your current fuel consumption rate in mpg – in litres/100 km on Canadian vehicles. This allows you to see whether your current driving style is conducive to fuel economy with minimum exhaust emissions.

When the vehicle is stationary the display goes to the maximum reading – zero on Canadian models.

Average fuel consumption

The average fuel consumption is calculated for the time during which the engine is running.

You can use the Control Display to view your fuel consumption rate over two different distances, refer to Computer or Trip computer.

Average speed

Periods with the vehicle parked and the engine off are not included in the calculations of average speed.

Time of arrival

A display of your estimated time of arrival is available whenever you enter a destination in the navigation system, refer to page 126, or enter the distance manually in the computer, refer to page 84, prior to departure.

 This function is only available if the time in the Control Display has been correctly set, refer to page 86. ◀

Control Display screen contents

You can activate the computer function at any time by selecting it from the "OB data" menu.

The computer furnishes you with a choice between two display options.

Computer



BC			
BC	Arrival	11/13/01	11:12AM
Limit	Beverly Hills		182 mls
	Range		519 mls
	Consumption		22.3 mpg
	Speed		48.5 mph

- ▷ Time of arrival
- ▷ Distance to destination.
Enter a destination in the navigation system, or enter a distance in the computer manually, refer to pages 126 and 84
- ▷ Cruising range
- ▷ Average fuel consumption
- ▷ Average speed.

 You can reset calculations of both average speed and average fuel consumption to zero. Select the menu entry and confirm. ◀

Trip computer

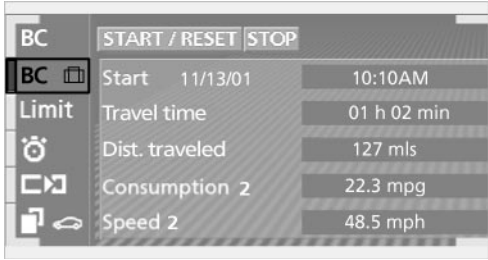

Reset all data to zero:
Select "START/RESET" and confirm.

- ▷ Time of departure
- ▷ Driving time
- ▷ Elapsed distance
- ▷ Average fuel consumption since "START/RESET"
- ▷ Average speed since "START/RESET"

To enter a distance manually

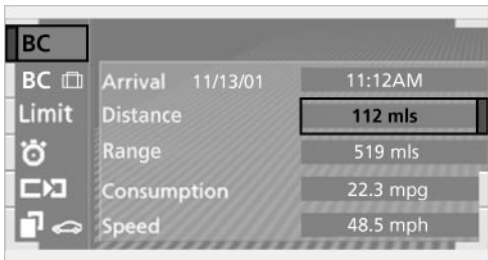

1. Select the computer ("BC")
2. Select and activate the "Distance" entry function. Turn the controller to the left or right to select the distance to your destination
3. Press the controller to confirm your entry.

Setting and revising speed limit

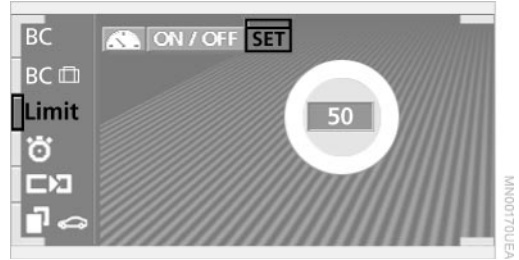

1. Select "Limit" and confirm your selection
2. Select "SET" and confirm
3. Turn the controller to the left or right to select the desired speed
4. Press the controller to confirm your entry. The speed limit function is now active.

Switch off or on again

1. Select "Limit" and confirm your selection
2. Select "ON/OFF" and confirm. "ON/OFF" is highlighted when the speed limit function is activated.

To adopt your current speed as the limit

1. Select "Limit" and confirm your entry
2. Select and confirm. The system adopts your current speed as the limit.

Info Display screen contents



If (for instance) the warning zone in the tachometer is visible, refer to page 77, the speed limit will be indicated by a warning sector in the speedometer, see arrow.

A message appears in the Check Control when you exceed the preset speed limit.

Vehicle speed must fall back to at least 3 mph (5 km/h) below the preset speed before the speed warning will be repeated.

Assistance window* for "OB data"

BC	BC
BC	Arrival 11/13/01 11:27AM
Limit	Beverly Hills 182 mls
	Range 519 mls
	Consumption 22.3 mpg
	Speed 48.5 mph

You can select any of the following computer functions for display in the assistance window:

- ▷ Computer
- ▷ Trip computer
- ▷ Speed limit

Stopwatch



Start and stop

1. ⌚ Select
2. ▶ Select and confirm. This resets the stopwatch to zero and then restarts it
3. ■ Select and confirm. This stops the timer.
Confirm again to reset the stopwatch to zero.

Taking an intermediate time reading



Select "INTERM. TIME" and confirm. This intermediate time appears below the ongoing primary stopwatch count.

▶ All of the remaining functions remain available at all times while the stopwatch is running. The stopwatch continues operation in the background. ◀

- ▷ Stopwatch

To import display

1. Select and confirm the desired function – here: computer
2.  Select and confirm. The function appears in the assistance window.

 The  symbol is highlighted if the function shown in the assistance window has been selected in the Control Display.

You can also choose to view brief "Help" texts explaining selected menu entries, refer to page 24, or the travel route on vehicles equipped with a GPS navigation system, refer to page 125.

Changing settings

Units of measure and display format

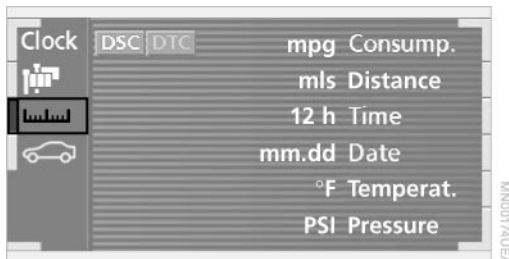

You can select the units of measure used in the displays of fuel consumption, distances, temperatures and pressures as well as the display format for the time and date.

1.  Select and confirm
2. Select the menu entry that you wish to adjust. Press repeatedly to view a listing of your selection options.

Language



You can select a different language for the text displays.

1.  Select and confirm
2. Select and activate the desired language.

Time and date



Select "Clock" and confirm.

To set the time

Select "Clock" and confirm. The first setting sector is highlighted.

- ▷ Turn to reset
 - ▷ Press to store your entry and proceed to the next setting.
- The clock adopts your entry the last time you confirm your entry.

Memo

You will hear three tones just before each full hour.

- ▷ Select "Memo" and confirm. "Memo" is highlighted when this function is activated.

Setting the date

Select "Date" and confirm. The first section of the date display is highlighted – here day.

▷ Turn to reset

▷ Press to store and highlight the next entry – here month and year.

Your date is adopted by the system the last time you store your entry.

Technology for comfort, convenience and safety

PDC Park Distance Control*

The concept

The PDC assists you when you are parking. Acoustic signals inform you of the distance to an obstacle. Four ultrasonic sensors in both the front and rear bumpers monitor the distance to the nearest object. The monitoring range of the front and two rear corner sensors extends outward roughly 2 ft (60 cm), while the rear bumper's two centrally located sensors detect objects at distances of up to approximately 4.9 ft (1.50 m).

Automatic function

Whenever the ignition is on the system automatically assumes operational status each time the selector lever is pressed briefly in R.

Manual activation



Press the button, the indicator lamp lights up.

The system is automatically deactivated once the vehicle travels approximately 165 ft (50 m) or exceeds a speed of roughly 18 mph (roughly 30 km/h); the indicator lamp goes out. You can reactivate the system manually as needed.

Manual deactivation

Press the button again; the indicator lamp goes out.

Acoustic signals

The signal indicating the distance to the nearest obstacle is directional. Thus, an object detected to the left rear of the vehicle will be indicated by a signal tone from the left rear speaker, etc. As the distance between vehicle and object decreases, the intervals between the tones become shorter. The signal tone becomes continuous once the distance to the nearest object falls to below roughly 1 ft (30 cm).

The warning signal is canceled after approximately 3 seconds when the distance to an object remains constant during this time (if you are moving parallel to a wall, for instance).

Malfunctions

The indicator lamp within the button flashes and a status message appears in the Check Control panel.

Please take note of the supplementary information provided in the Control Display.

Switch the system off and have the cause of the malfunction corrected by your BMW center.

PDC with visual alert

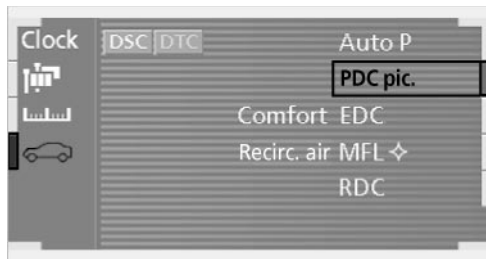

You also enjoy the option of having the system show distances to objects in the Control Display. The Control Display will also indicate the presence of objects in green before they are close enough to generate a signal tone.

Select "PDC pic." from the "Settings" menu and confirm your selection. This activates the PDC display.

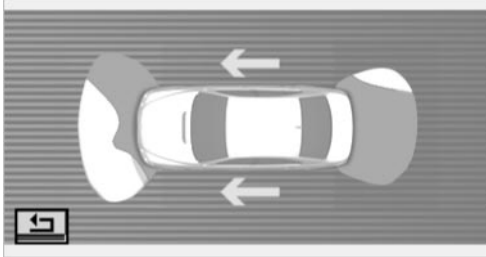

The display then appears in the Control Display whenever PDC is automatically or manually activated.

The previous display automatically reappears after the system is deactivated.

 Confirm  in the menu to return to the previous display. ◀

 Even with PDC, final responsibility for estimating the distance between the vehicle and any obstructions always remains with the driver. Even when sensors are involved, there is a blind spot in which objects cannot be detected. The system is also subject to the physical limits that apply to all forms of ultrasonic measurement, such as those encountered with tow bars and trailer couplings, as well as thin and wedge-shaped objects, etc. After initial detection, low objects such as curbs, etc., may disappear again before the system starts to generate a continuous warning tone. Loud noises from outside and inside the vehicle may prevent you from hearing PDC's signal tone. ◀

 Keep the sensors clean and free of ice or snow in order to ensure that they will continue to operate effectively. Do not apply high pressure spray to the sensors for a prolonged period of time.

Keep the spray at least 4 in (10 cm) away from the sensors. ◀

Driving stability control/ DSC Dynamic Stability Control

Your BMW is equipped with an extended array of systems designed to enhance and maintain vehicle stability under extreme conditions. The following section describes these functions based on DSC and ABS.

The concept

DSC maintains vehicle stability, even in critical driving situations.

The system optimizes vehicle stability during acceleration and when starting from a full stop, as well as optimizing traction. The system recognizes any tendency for the vehicle to assume an unstable attitude such as oversteer or understeer; it then counteracts this tendency with a combination of graduated reductions in engine torque and selective braking intervention at individual wheels. DSC provides optimal stability within the limits defined by the laws of physics.

The DSC is operational every time you start the engine. DSC includes the functionality of the DTC Dynamic Traction Control and DBC Dynamic Brake Control.

With its selective braking intervention at the individual drive wheels, DTC fulfills the same function as a conventional limited-slip differential to enhance traction under difficult driving conditions, such as on snow, etc.

Indicator lamps

 The indicator lamp in the Info Display goes out soon after you start the engine.

If the indicator lamp flashes:
DSC controls the drive and braking forces.

The indicator lamp stays lit:
DSC has been switched off via the Control Display.



The indicator lamp and the brake warning lamp remain on continuously:



DSC, DTC and DBC have been deactivated or a system malfunction is present.

When the system is off, the stability maintenance functions described above are no longer available. The vehicle will remain completely operational, however, without DSC.

Please respond to any malfunctions by referring the problem to your BMW center.



Indicator and warning lamps on Canadian models.



Activating DTC Dynamic Traction Control

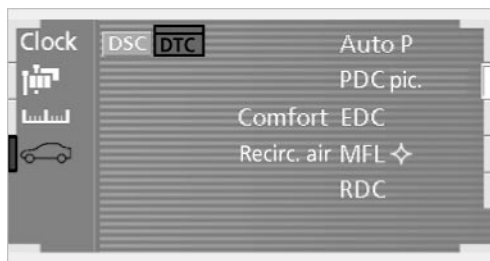

You may find it useful to briefly activate DTC under the following special circumstances:

- ▷ When rocking the vehicle and starting off in deep snow or on loose road surfaces
- ▷ When ascending snow-covered hills, and when driving in deep or on hard-packed snow
- ▷ When driving with snow chains.

Select the "Settings" menu. Select "DTC" and confirm your entry. DTC is now activated. The "DTC" indicator lamp in the Control Display lights up.



When DTC is operating, DSC is restricted to limited functionality up to vehicle speeds of approx. 45 mph

(70 km/h). Control intervention to maintain stability is reduced. ◀

To deactivate DTC again

Select the "Settings" menu. Select "DTC" and confirm your entry. DTC is now deactivated. The "DTC" indicator lamp in the Info Display goes out.

To deactivate DSC



Select the "Settings" menu. Select "DSC" and confirm your entry. DSC is deactivated. The indicator lamp in the Info Display remains on continuously.

Deactivating DSC automatically deactivates DTC as well. The systems for enhancing stability and traction are deactivated, and there is no active braking intervention or torque control.

A status report appears in the Check Control panel. Please take note of the additional information in the Control Display panel.



To maintain optimal stability, drive with the system on whenever possible. ◀

To reactivate DSC

Select the "Settings" menu. Select "DSC" and confirm your entry. DSC is now on. The indicator lamp in the Info Display goes out.



The laws of physics cannot be repealed, even with DSC. An appropriate driving style always remains the responsibility of the driver. Avoid using the additional safety margin provided by the system as an excuse for taking unnecessary risks.

When DTC is active, DSC provides only

limited system response up to a speed of approx. 45 mph (70 km/h). Intervention for stability-enhancement is reduced. Do not make any modifications to the DSC system. Never allow anyone other than authorized professional technicians to carry out service or repairs on the DSC system. ◀

Dynamic Brake Control DBC

When you apply the brakes rapidly, this system automatically produces the maximum braking force boost and thus helps to achieve the shortest possible braking distance during "panic stops." This system exploits all of the benefits provided by ABS.

Do not reduce the pressure on the brake pedal for the duration of the brake application. When the brake pedal is released, the DBC is deactivated.

 In the event of a malfunction, the warning lamp comes on with a yellow lamp. Have the system checked and repaired at your BMW center as soon as possible.

Check Control messages, refer to page 80. Please note the supplementary information provided in the Control Display.

 Warning lamp on Canadian models.

Driving stability control/ ABS Antilock Brake System

The concept

ABS enhances active safety by preventing the wheels from locking under braking.

ABS incorporates CBC and EBV.

In case of malfunction

 If the indicator lamp lights up in yellow, this indicates that ABS has been deactivated in response to a system malfunction. Conventional braking efficiency remains available without limitations. Please have the system inspected at your BMW center.

Cornering Brake Control CBC

CBC is a technical advance based on ABS. It provides further enhancements in vehicle stability and steering response during lane changes and cornering at high rates of lateral acceleration.

EBV Electronic brake-force distribution

EBV controls the brake system's application pressure at the rear wheels to ensure stable deceleration.

In case of malfunction

 If the brake system warning lamp lights up in red, appearing together with the yellow lamps for ABS and DSC: the stability control is no longer operational.

 If all three lamps light up in yellow: malfunction in the stability control systems.

While you may continue, you should remember to proceed cautiously and drive defensively while avoiding full brake applications.

Please have the system checked at the nearest BMW center.

Check Control status messages, refer to page 80. Please note the supplementary information provided in the Control Display.

 Indicator and warning lamps on Canadian models.

Dynamic Drive

The concept

Dynamic Drive minimizes body roll and optimizes vehicle stability during cornering and evasive maneuvers.

Active stabilizers at the front and rear axles form the basis for Dynamic Drive. Suspension compliance adapts to suit driving conditions, varying from performance-oriented during cornering to smooth and comfort-oriented when the vehicle is proceeding in a straight line.

The system assumes operational status each time you start the engine.

Driving with Dynamic Drive

During vehicle operation, the system continuously runs through closed-loop control cycles lasting only fractions of a second.

In case of malfunction



The symbol will light up, accompanied by a status message in the Check Control panel. Please take note of the additional information in the Control Display panel.

You can find more detailed information on the Check Control starting on page 80.



If the Dynamic Drive system switches off in response to malfunction, please remember to adapt your speed accordingly, especially in curves. The suspension will be noticeably softer and the vehicle will display a greater tendency to tilt during cornering and in crosswinds.

If a status message appears in the Check Control panel, accompanied by a red symbol, the hydraulic fluid in the reservoir may have fallen to below the minimum level, possibly owing to leakage in the hydraulic system. Stop the vehicle and switch off the engine immediately. Please observe the additional instructions provided in the Control Display panel. ◀

EDC Electronic Damping Control*



The suspension responds to changes in factors such as road surface, or operating conditions such as steering and braking, by adapting to the new conditions within fractions of a second.

Comfort program

The system automatically assumes operation in its Comfort mode each time you start the engine; this mode is suitable for use throughout the vehicle's entire speed range and regardless of load.

Sport program

Activate in "Settings" menu with the ignition on.

You should select the Sport program for consistently performance-oriented response from shock absorbers and steering.

RDC Tire Pressure Monitor*

The concept

RDC monitors inflation pressures in all four tires while you drive. The system provides an alert whenever the inflation pressure drops significantly below the specified pressure in one or more tires.

To initialize RDC, start by checking the inflation pressures in all four tires and comparing them with those specified in the chart on page 171, correcting them as necessary. Then proceed to initialize the system.



This symbol will appear in the Check Control panel to inform you when the inflation pressure varies from that stored in the system. A text message appears at the same time. Please take note of the additional information in the Control Display panel. You can find more information on the Check Control starting on page 80.



The RDC cannot alert you to severe and sudden tire damage caused by external factors. ◀

To initialize the system



1. With the vehicle parked, switch on the ignition
2. Select "RDC" from the "Settings" menu and confirm your selection. The initialization menu appears.

"INITIALIZE"

1. Select and confirm

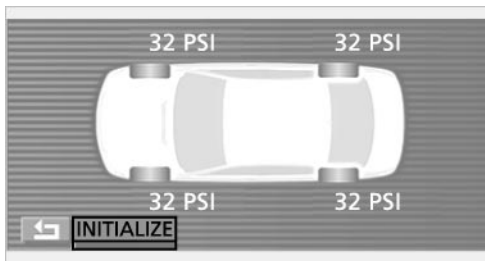

2. RDC is initialized. A message appears in the Check Control panel
3. After several minutes of driving RDC will adopt the tires' current inflation pressures as its references. The current data appear in the Control Display. These figures are more accurate

than those that appear on the inflation gauges at filling stations, etc.

The only time you will need to repeat this procedure is after correcting your tire pressures. Because RDC automatically assumes operation each time you switch on the ignition, it is on duty whenever you drive.



If the system detects a flat tire during the initialization process, the tires in the Control Display will appear in red. ◀

Do not start initialization

◀ Select and confirm to return to the "Settings" menu.

Status indicators in the Control Display

The status of the system is indicated by the color of the tires.

Green

Tire inflation pressures correspond to the initialized level.

Yellow

The inflation pressures in the tires have fallen to below the specified level, which is normal in every tire after a certain amount of time.

This alerts you to have the tires inflated to the specified pressures as soon as possible.

Red

Pressure loss in indicated tire.

If this occurs, reduce vehicle speed immediately and stop the vehicle. Avoid hard and sudden steering and braking maneuvers.

Black

The system is being initialized.

The system needs several minutes to complete the initialization process, after which it is ready to detect and report tire problems.

In the event of loss in tire pressure

If the indicator lamp symbol in the Check Control lights up in yellow, and a message also appears, this indicates that the inflation pressures in the tires have fallen to below the specified level, which is normal in every tire after a certain amount of time.

This alerts you to have the tires inflated to the specified pressures as soon as possible.

Please take note of the additional information in the Control Display panel.

 If you are prompted to check the tire pressure shortly after a correction has been made, this indicates that the corrected values were not accurate. Please check the inflation pressure again and make corrections according to the inflation pressure table. Then reinitialize the system. ◀

Flat tire

If you have a flat tire, the indicator lamp symbol in the Check Control will light up in red, and a message will appear. In addition, a gong sounds.

If this occurs, reduce vehicle speed immediately and stop the vehicle. Avoid hard and sudden steering and braking maneuvers. Replace the damaged tire.

 The spare tire provided with your vehicle is equipped with the electronics required to support RDC operation; once the spare tire is installed, the pressure in this tire will also be monitored following system initialization.

Have the tires changed at your BMW center. Your BMW center has the information needed for working with RDC and is equipped with the necessary special tools. ◀

System malfunctions

Other equipment operating on the same radio frequency as RDC can generate interference signals that may prevent the system from operating as intended.

The symbol will appear in yellow in the Check Control panel and a message will appear.

You will also see the same message

- ▷ in the event of a system fault
- ▷ if a wheel is mounted without the appropriate electronics
- ▷ if, in addition to the spare tire, additional wheels with RDC electronics are on board.

Please refer to the additional information supplied in the Control Display, and have the system inspected at your BMW center.

Self-leveling suspension*

In the event of malfunction



A Check Control message appearing together with this symbol indicates a malfunction in the self-leveling suspension. Please take note of the additional information in the Control Display panel.

Stop and inspect the vehicle. If the rear of the vehicle is visibly lower than the front, possibly accompanied by a tilt noticeable when you compare the left rear with the right rear, you should respond by immediately proceeding to the nearest BMW center. Drive with appropriate caution in the meantime. The vehicle has reduced ground clearance and driving comfort may be noticeably reduced. Even if the attitude of the vehicle is normal, you should consult the nearest BMW center if the warning lamp indicates a system fault.

Adaptive brake lamp

The adaptive brake lamp indicates the intensity with which you are applying your brakes to drivers of following vehicles.



MM01237UEA

The display consists of two stages:

▷ Normal braking:

The brake lamps in the tail lamp assemblies and the high-mount brake lamp on the rear tray light up during braking.

▷ Heavy braking and braking with ABS:

The tail lamps also light up with the same intensity as the standard brake lamp units to enhance the warning effect of the brake lamps.

Lamps

Parking lamps/low beams

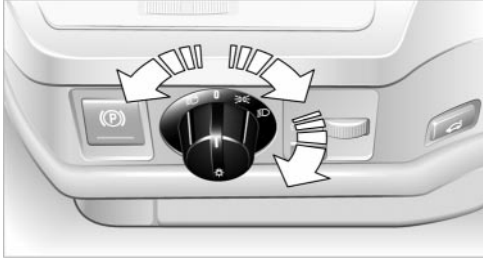

1M01221UEA

Parking lamps (side marker lamps)



With the switch in this position, the front, rear and side vehicle lighting is switched on. You can use the side marker lamps for parking. For lighting on one side for parking as an additional feature, refer to page 97.

Low beams



When you switch off the ignition with the headlamps on, the headlamps go out, and only the parking lamps remain on.



"Follow me home" lamps: After parking the vehicle and switching off the headlamps, you can use the headlamp flasher control to activate the headlamps (low beam) for a period of roughly 40 seconds. You also have the options of extending this period or, as an alternative, having this function deactivated. ◀

"Lamps on" warning

If you switch off the ignition while the headlamps are on, when you subsequently open the driver's door a buzzer will sound for several seconds, while the Check Control will provide you with an additional reminder in the form of a message alerting you to the fact that the headlamps have not been switched off.

Daytime driving lamps*

If you wish, you can leave the light switch in the low-beam position: All external lamps go out when you switch off the ignition.

Always observe all applicable laws governing the use of daytime driving lamps.

You can switch on the parking lamps when needed using the standard procedure described under Parking lamps.



You can have the daytime driving lamps on your vehicle programmed to operate as desired. ◀

Automatic headlamp control



When you set the switch to this position, the system activates and switches the headlamps on and off (low beams) in response to changes in ambient light conditions, for instance, in tunnels, at dawn and dusk, and in rain and snow. The green indicator lamp next to the symbol is illuminated when the low beams are on.



Following automatic activation the vehicle's external lighting remains on when you switch on the fog lamps. ◀



The automatic headlamp control cannot serve as a substitute for your personal judgment in determining when the lamps should be switched on in response to ambient lighting conditions. For example, the system cannot detect fog. To avoid safety risks, you should always switch on the lamps manually under these conditions. ◀



You can have the sensitivity of the headlamp control system adjusted on your vehicle. ◀

Instrument lighting



MAV01222UJEA

Turn the rotary dial to adjust the illumination intensity.

High beams/standing lamps

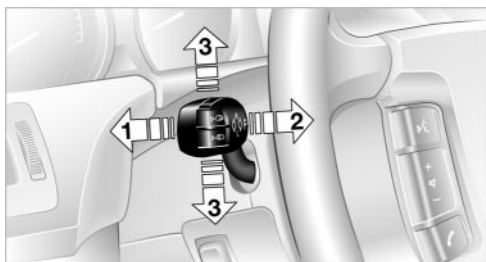

MAV00715QMA

- 1 High beams – blue indicator lamp
- 2 Headlamp flasher – blue indicator lamp
- 3 Standing lamp

Standing lamps, left and right*

You also enjoy the option of lighting up just one side of your vehicle when parking:

With the ignition off, press the lever in the desired direction 3, past the pressure point.

Front fog lamps



MAV01223UJEA

 The parking lamps or low beams must be switched on for the fog lamps to operate. The green indicator lamp in the Info Display lights up whenever the fog lamps are on.

The fog lamps are switched off whenever the high beams are switched on.

 If the automatic headlamp control is activated, the headlamps (low beam) will come on automatically when you switch on the fog lamps. ◀

Interior lamps

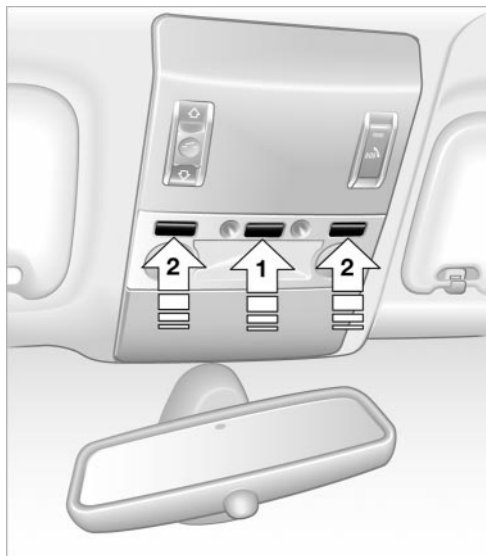

MAV00896CMA

The interior lamps operate automatically.

Switching the interior lamps on and off

Briefly press button 1.

If you want the interior lamps to remain off continuously, maintain pressure on the button for approx. 3 seconds.

To revert to normal operation, press the button briefly.

The button for the interior lamps in the rear passenger area only switches these lamps on and off.



The interior lamps come on briefly whenever you use the parked-car ventilation system. This feature confirms that the system has been activated. ◀

Control of the footwell lamps, courtesy lamps and ground lamps is also automatic.

Reading lamps

Reading lamps are provided in the front and rear* adjacent to the interior lamps. You can switch them on and off using the buttons 2 located next to the lamps.



To avoid discharging the battery, all of the vehicle's interior lamps are automatically switched off approx. 15 minutes after the ignition is switched off. ◀

Light-emitting diodes - LEDs

Light-emitting diodes installed behind translucent lenses serve as the light source for many of the controls and displays in your vehicle. These light-emitting diodes, which operate using a concept similar to that applied in conventional lasers, are officially designated as Class 1 light-emitting diodes.



Do not remove the covers, and never stare into the unfiltered light for an extended period (several hours), as irritation of the iris could result. ◀

A congenial climate

Automatic climate control

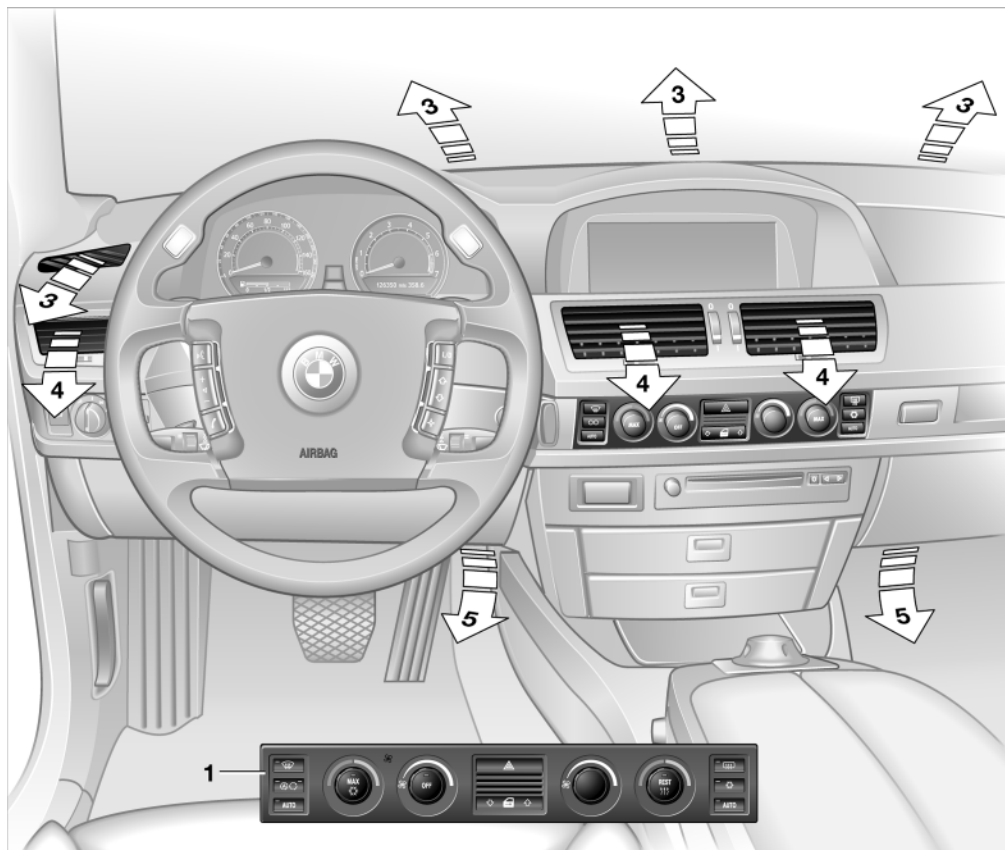

- 1 Automatic climate control
- 2 Airflow directed toward the windshield and side windows
- 3 Airflow for the upper body
The serrated dials in the center open and close through an infinitely-variable range to control air supply while also adjusting the air's direction like the lower serrated dials. You can find more information on adjusting for draft-free ventilation on page [104](#)
- 4 Front footwell ventilation

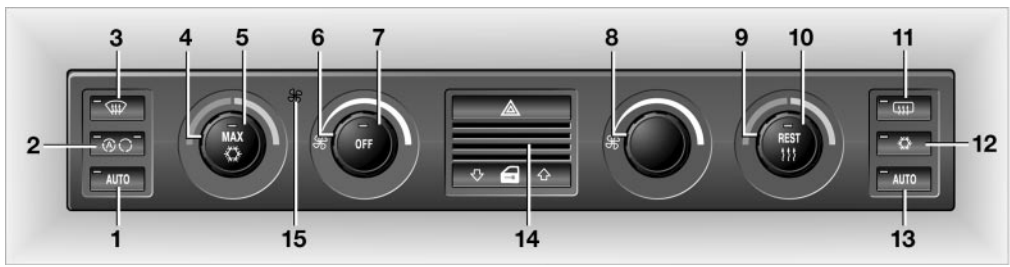

AV011010CHA

- 1 Automatic air distribution and supply – left side of passenger compartment 103
- 2 External air/AUC Automatic recirculated air control/Recirculated air 101
- 3 To defrost windshield and door windows 101
- 4 Temperature control – left-hand side, see next column
- 5 Maximum cooling 101
- 6 Air supply – left-hand side 101
- 7 To switch off automatic climate control 103
- 8 Air supply – right-hand side 101
- 9 Temperature control – right-hand side, see next column
- 10 Residual heat mode 101
- 11 Rear window defroster
- 12 Air conditioner 101

- 13 Automatic air distribution and supply – right side of passenger compartment 103
- 14 Air grill for interior temperature sensor – please keep clear and unobstructed
- 15 Parked-car ventilation system 106
 - ▷ Activation time set – the indicator lamp is on
 - ▷ Parked-car ventilation on – the indicator lamp flashes

 All of the remaining setting options available with the automatic climate control can be found in the Control Display's "Settings" menu, refer to page 103.

The current settings for temperature and air supply appear in the Control Display's status line. You can find a description of the Control Display on page 19. ◀

A congenial climate

Activate the automatic mode using the AUTO button or "AUTO" in the Control Display, refer to page 103. Select the interior temperature that you find most comfortable.

The following section contains more detailed information on the available setting options.

 All of the air conditioner functions, including maximum cooling, refer to page 101 and the rear air conditioner, see page 105 are available only when the engine is running. ◀

 Your vehicle has been designed to automatically select your personal climate-control settings whenever you

unlock the doors using your individually programmed remote control unit. ◀

Automatic air distribution and supply

 The AUTO program adjusts the air supply and distribution patterns for you while also using your preselected temperature setting as the basis for adjusting the interior climate to adapt to external influences – summer, winter.

Temperature adjustment



You can turn to select the desired temperatures for the driver's and passenger sides. Your settings appear in the Control Display's status line.

The figures in the display provide a general indication of interior temperature. When you start the vehicle, this system ensures that the selected temperature is achieved as quickly as possible. It then maintains this temperature, regardless of the season.

Defrost windows and clear them of condensation



This program quickly removes ice and condensation from the windshield and door windows.

To adjust air supply manually



You can adjust the air supply by turning. The automatic air supply control is operational whenever you see your selection represented by a bar in the Control Display's status line. The automatic air distribution remains in operation as before. You can reactivate the automatic air supply mode with the AUTO button.

Air conditioner operation



The air conditioner cools and dehumidifies the incoming air before also reheating it as

required, according to temperature setting. Depending on the weather, the windshield may fog over briefly when the engine is started.

The air conditioner comes on automatically when you select the AUTO program.

Maximum cooling



Select this program to obtain maximum cooling as quickly as possible.

The temperature display reverts to 61 °F (16 °C) while the system switches to the recirculated-air mode and starts to provide maximum air supply through the

instrument panel outlets only. For this reason you should ensure that these outlets are open before selecting this program.

Outside air/AUC Automatic recirculated-air control/Recirculated air



You can respond to unpleasant odors or pollutants in the immediate environment by temporarily suspending the flow of outside air. The system then recirculates the air currently within the vehicle. AUC executes this function automatically.

Press the button repeatedly to run through the following control sequence:

- ▷ Indicator lamps off: outside air flows into the vehicle
- ▷ Left-hand indicator lamp on – AUC mode: the system detects pollutants in the outside air and responds by deactivating the outside air supply when required. The system then recirculates the air currently within the vehicle.

Depending upon air quality, in the automatic mode the system may start to alternate between its outside-air and recirculated-air modes

- ▷ Right-hand indicator lamp on – Recirculated-air mode: the supply of outside air into the vehicle is permanently blocked. The system then recirculates the air currently within the vehicle.



If condensation starts to form on the inside window surfaces during operation in the recirculated-air mode, you should switch it off while also increasing air supply as required. ◀

Residual heat mode



The system uses the warmth stored in the engine to heat the interior when the ignition is off, for instance, while the vehicle is stopped at a school to pick up a

child.

You can adjust the automatic climate control's settings when the ignition lock is in the radio mode. The system blows

heated air into the interior in accordance with the selected distribution pattern while the ignition is off.

▶ Provided that the engine has warmed up to its normal operating temperature and the battery is charged, you can use this function for up to 15 minutes after switching off the ignition. The LED within the button lights up to confirm compliance with both of these conditions. ◀

Front ventilation

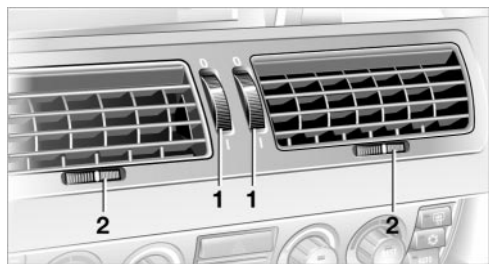

You can adjust the vent outlets for the upper body to suit your personal requirements.

You can use the serrated dials 1 to open and close the outlets through an infinitely-variable range, while the serrated dials 2 allow you to adjust the airflow direction.

Ventilation for cooling

Adjust the vent outlets to direct the flow of cool air in your direction, for instance, if the interior has become too warm, etc.

Draft-free ventilation

Set the vent outlets so that the air flows past you and is not directed straight at you.

▶ The airflow temperatures for the individual upper-body vent outlets can be adjusted separately in the Control Display, refer to page 104.

When the vent outlets are completely closed, the vents at the top of the cockpit provide indirect ventilation for the passenger compartment. ◀

Ventilation for storage compartment in front armrest

You can use the serrated dial in the storage compartment to open and close the vent outlet.

▶ Depending upon the temperatures selected at the rear dials, high temperatures may occur in the storage compartment. Close the vent as required. ◀

Rear ventilation

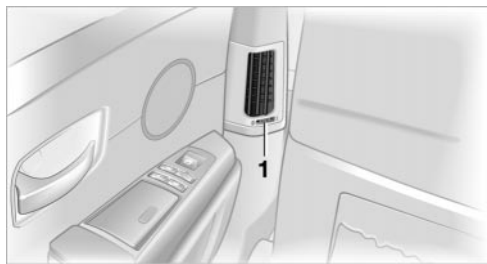

The serrated dials 1 allow you to open and close the ventilation outlets through an infinitely-variable range.

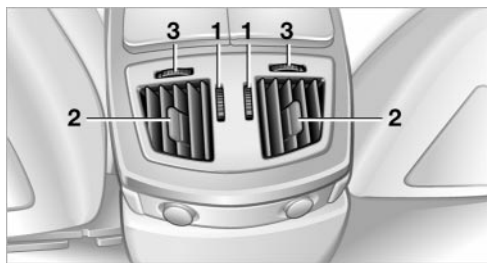

You can adjust the airflow direction using the levers 2

The serrated dials 3* control the amount of cooled air in the flow from the vent outlets:

Turn toward blue sector – colder
Turn toward red sector – warmer

This function allows you to make minor adjustments for maximum comfort while also letting you vary temperatures within the storage compartment.

Switching off the automatic climate control*



The air supply, the heater and the air conditioner are all switched off. You can restart the automatic climate control by pressing any of its buttons except the REST button.

Settings in Control Display

With the ignition on, select the "Climate" menu in the Control Center. The Control Display provides you with the following setting options:

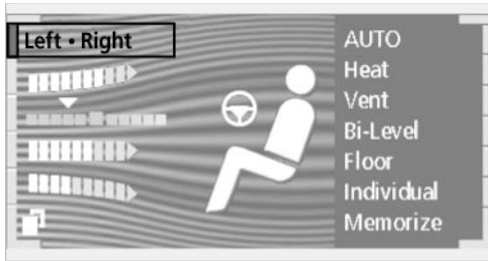

- ▷ "Left • Right": Separate settings for driver and front passenger
- ▷ To adjust and adapt air-distribution patterns, refer to the next column
- ▷ To adjust temperature for the upper body, refer to page 104
- ▷ To store and select individual settings for air supply, air distribution and temperature, refer to page 104

☑ Select the second page of the "Climate" menu

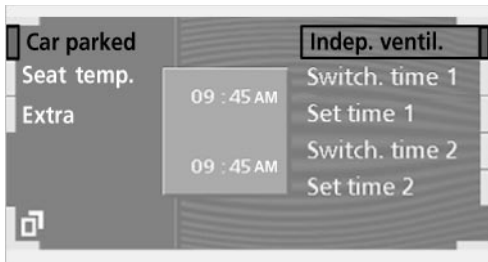

- ▷ Select "Indep. ventil.": For information on activating and deacti-

vating the parked-car ventilation system and setting the timer, refer to page 106

- ▷ "Seat temp.": To adjust temperature distribution while the seat heaters are on, refer to page 51
- ▷ "Extra": Switching rear air conditioner and rear cooler on and off, refer to pages 105, 110

☑ Select the first page of the "Climate" menu

Automatic air distribution and supply

"AUTO":

The AUTO program adjusts the air supply and distribution patterns for you while also using your preselected temperature setting as the basis for adjusting the interior climate to adapt to external influences – summer, winter.

"Bi-Level":

This program operates in the same way as the AUTO program, but with airflow directed toward upper body and into the footwells.

For individual adjustment of air-distribution patterns

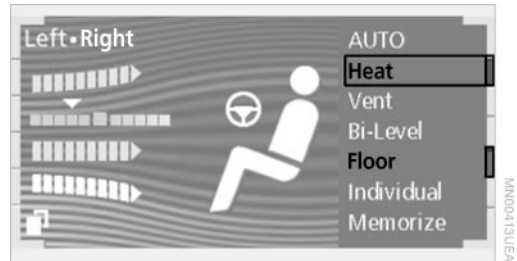

You can cancel the AUTO program by selecting specific air distribution patterns for your personal comfort.

To adjust air distribution

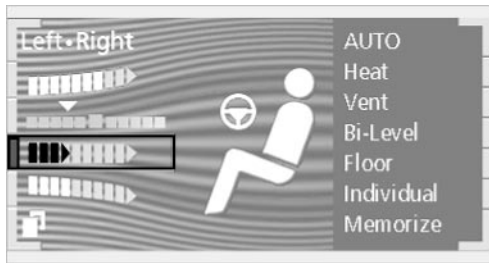

You also enjoy the option of adjusting the air distribution manually to obtain a climate that is ideally adapted to your personal requirements. The AUTO program is deactivated.

Select the desired symbol and confirm. Turn the controller to adjust the air distribution.

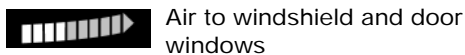

Air to windshield and door windows

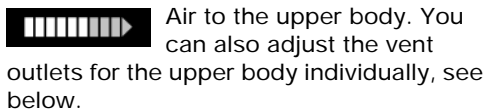

Air to the upper body. You can also adjust the vent outlets for the upper body individually, see below.



Air to footwell

To adjust temperature for the upper body

This function provides you with the option of making minor adjustments to achieve maximum comfort.

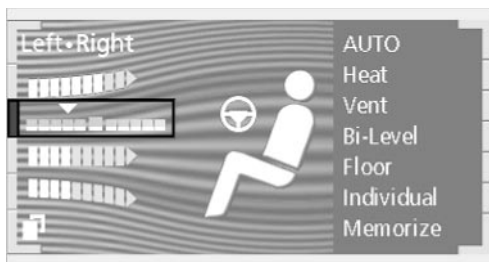

Use the temperature setting to adjust the amount of cool air that is added to the airflow emerging from the vent outlets for

the upper body. We recommend a moderate temperature setting, as cooler air helps promote fatigue-free driving.

To store and select individual settings

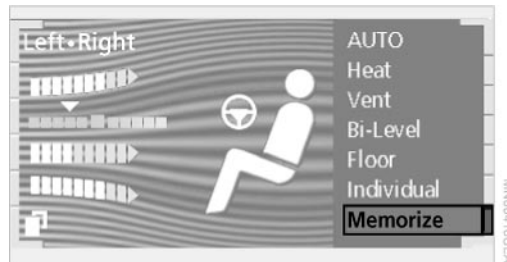

You can store your individual setting after adjusting the air distribution manually.

Select "Memorize" and confirm your selection.

Now you can reselect the preset climate that precisely reflects your personal requirements.

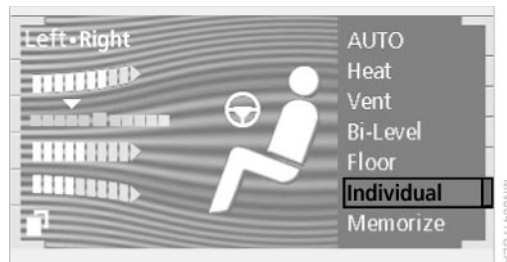

Select and confirm "Individual." The AUTO program is deactivated.

Microfilter/activated-charcoal filter

The microfilter removes dust and pollen from the incoming air. The activated-charcoal filter provides additional protection by filtering gaseous pollutants from the outside air. Your BMW center replaces this combined filter as a standard part of your scheduled maintenance.

You can select a display of more detailed information in the Service Display, refer to page 78.

Rear air conditioner*

The following settings and operating modes can be selected and adjusted separately on the left and right sides:

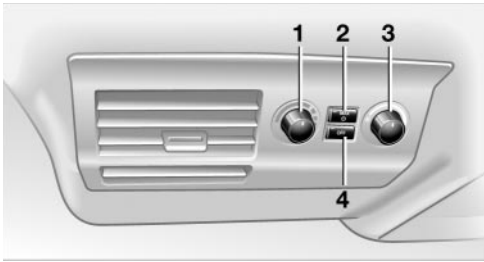

- 1 Cooling adjustment, see below
- 2 Maximum cooling, see below
- 3 Adjust air supply manually, see below
- 4 Switch off rear air conditioner, see below

Rear air conditioner activation

To switch on the rear air conditioner

- ▷ select maximum cooling
- ▷ press the OFF button again
- ▷ select "Rear air cond." in the Control Display and confirm your selection, see below.

 The rear cooler is automatically activated when you switch on the rear air conditioner, refer to page 110. ◀

To adjust cooling



You can also set the system to provide the desired level of cooling by turning. We recommend setting the system for moderate cooling. When you start off, the system reaches and then maintains the desired temperature settings as quickly as possible, both in summer and in winter.

To adjust air supply manually



You can adjust the air supply by turning.

Maximum cooling



This program quickly provides maximum cooling.

The system automatically switches to the recirculated-air mode while a high-speed stream of air simultaneously emerges from the outlet in the instrument panel. For this reason you should ensure that these outlets are open before selecting this program.

Switching off rear air conditioner





The air conditioner is switched off.

Press the button again to switch back on.

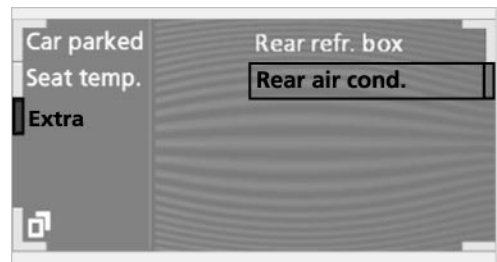
Switching on/off in Control Display



1. With the ignition on, select "Climate" in the Control Center menu
2.  Select the second page of the "Climate" menu
3. Select "Extra" and confirm
4. Select "Rear air cond." and confirm.

 The maximum cooling mode is automatically activated when you switch on the rear air conditioner in the Control Display. ◀

Select "Rear air cond." again and confirm your entry to deactivate the system.

Rear ventilation



Use the lever 1 to vary the airflow direction. For additional information on rear ventilation options, refer to page 102.

Parked-car ventilation system

System operation is controlled using the Control Display. You can set two different times for the system to start.

The parked-car ventilation blows air into the passenger compartment to lower interior temperatures.

The system remains on for 30 minutes. You can also switch the system on and off manually. Since the system uses a substantial amount of electrical current, you should refrain from activating it twice in succession without allowing the battery to be recharged in normal operation between use.

The parked-car ventilation system is available for preprogrammed operation at outside temperatures above approx. 50 °F (10 °C) and for direct activation at any temperature, but is not operational when the vehicle is underway.

The air enters the passenger compartment through the vent outlets in the instrument panel, which can be adjusted for both direction and airflow. These outlets must be open for the system to operate.

Activating and switching off manually

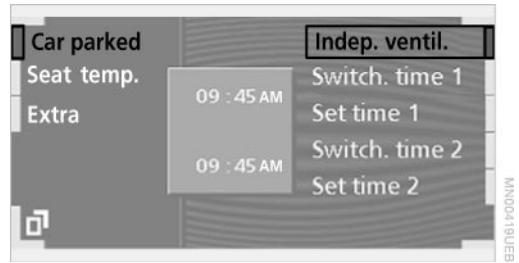

1. Activate the "radio" mode at the ignition lock
2. Select "Indep. ventil." on the second page of the "Climate" menu and confirm your selection.

Select "Indep. ventil." a second time and confirm to deactivate the system manually.

To set the timer

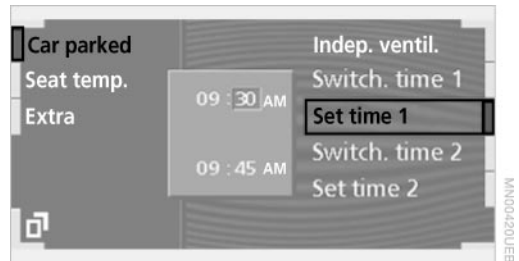

You can preselect two activation times.

1. Activate the "radio" mode at the ignition lock
2. Select "Indep. ventil." from the second page of the "Climate" menu and confirm your selection
3. Select "Set time 1" or "Set time 2" and confirm your selection
4. Enter the desired time
 - ▷ Turn: set
 - ▷ Press: confirm.

To activate timer

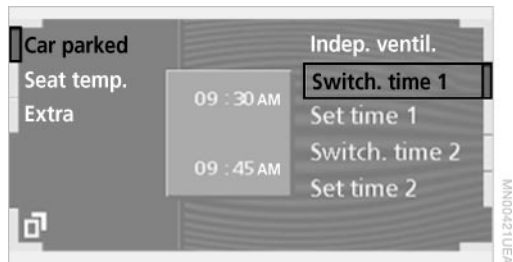

Select "Switch time 1" or "Switch time 2" and confirm your selection.

 The parked-car ventilation is only available for activation within the subsequent 24 hours. After this the time will have to be reconfirmed. ◀

Practical interior accessories

Universal Garage Door Opener*

The concept

The Universal Garage Door Opener can replace as many as three hand-held transmitters for various accessories, such as door openers, alarms and door-locking systems. The Universal Garage Door Opener registers and stores signals from the original hand-held transmitters.

The signal of an original hand-held transmitter can be programmed on one of the three channel keys. Following that, each of the devices can be actuated with the appropriately-programmed channel key. The indicator lamp flashes to confirm transmission of the signal.

If the vehicle is sold, the memory of the channel keys should be cleared as described on page 109.

 To prevent possible damage or injury, before programming or using the Universal Garage Door Opener always inspect the immediate area to make certain that no people, animals or objects are within the travel range of the device. Also, comply with the safety precautions of the original hand-held transmitter. ◀

Original hand-held transmitter

 If you see this symbol on the packaging or in the manual supplied with the original remote control unit, it is safe to assume that it is compatible with the Universal Garage Door Opener.

To check for alternating codes

To determine whether the original hand-held transmitter operates using an alternating code, you should either consult the manual enclosed with it or program a channel key as described in the Programming section.

After programming, press and hold down the key on the Universal Garage Door Opener. If the indicator lamp on the Universal Garage Door Opener flashes for two seconds before remaining on continuously, this indicates that the original hand-held transmitter uses an alternating code. In this case, you can program the channel keys using the procedure described on the next page in the section on programming alternating-code transmitters.

 If you have additional questions, please consult your BMW center or call 1-800-355-3515.

You can also visit these websites:

www.bmwusa.com or

www.homelink.com.

HomeLink is a registered trademark owned by Johnson Controls, Inc. ◀

Programming

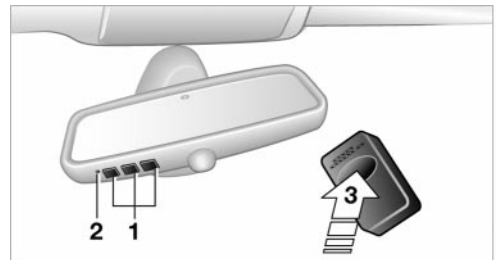

1 Channel keys

2 Indicator lamp

 Observe the safety precautions described in the previous column. ◀

1. Switch on the ignition

2. When using for the first time: press both outside keys 1, maintaining pressure until the indicator lamp 2 starts to flash, then release them. The three channel keys are cleared.

3. Hold the original hand-held transmitter no further than 2 in (5 cm) from the channel keys

4. Simultaneously press the transmit key on the original hand-held transmitter, arrow **3** and the selected channel key **1** on the Universal Garage Door Opener. Release both keys as soon as the indicator lamp flashes rapidly

5. To program other original hand-held transmitters, repeat steps 3 and 4.

The corresponding channel key is now programmed with the signal of the original hand-held transmitter.

Programming alternating-code transmitters

 Observe all of the safety precautions described on the previous page. ◀

Consult the unit's operating instructions when programming the Universal Garage Door Opener.

When programming hand-held transmitters that employ an alternating code, please observe the following supplementary instructions:

 Programming will be easier with the aid of a second person. ◀

1. Program the Universal Garage Door Opener by following the instructions given above under Programming.

2. Maintain pressure on the alternating-code transmitter for roughly two seconds, continuing until the program lamp lights up.

3. Press the selected channel key on the Universal Garage Door Opener three times.

 If you have any additional questions, please contact your BMW center. ◀

To clear channel keys

 Observe all of the safety precautions described on the previous page. ◀

The memory of individual channel keys cannot be deleted. However, the three channel keys can be cleared together as follows:

▷ Press both outside keys on the Universal Garage Door Opener; maintain pressure until the indicator lamp starts to flash, then release the key.

Sun blinds*

Rear window sun blind



Activate by pressing the button with the ignition lock in the "radio" mode.

Sun blinds for rear windows

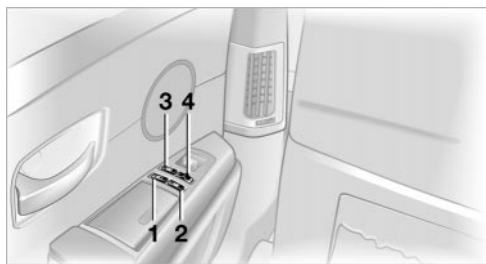

Activate by pressing the desired button with the ignition lock in the "radio" mode.

1 Quarter window blind

2 Side window blind

3 Rear window blind

4 Switching to the other side

 The side window blind cannot be extended unless the side window is closed. If the window is open, the blind will rise slightly prior to immediately retracting to its original position. ◀

 Briefly press the safety switch in the driver's door, refer to page 42. The indicator lamp must light up. This precaution prevents children from operating the sun blinds using the rear switches, etc. Before using always ensure that the sun blind's travel path is clear and unobstructed.

When leaving the vehicle, always remove the remote control unit from the ignition

lock and close the doors; this precaution prevents children from using the sun blinds and injuring themselves, etc. ◀

To automatically extend and retract the sun blinds

You can extend and retract the sun blinds together by briefly pressing button 3.

Rear cooler*



The cooler is located behind the rear seats' center armrest.

To activate

Press the button, see arrow 1, the indicator lamp within the button comes on.

▶ On vehicles equipped with a rear air conditioner unit, once switched on the rear cooler operates whenever the engine is running. ◀

To open

Pull the handle, see arrow 2

To switch on/off in Control Display*

▶ When you switch on the rear air conditioner, this also activates the rear cooler, which will then refrigerate its contents whenever the engine is running. ◀

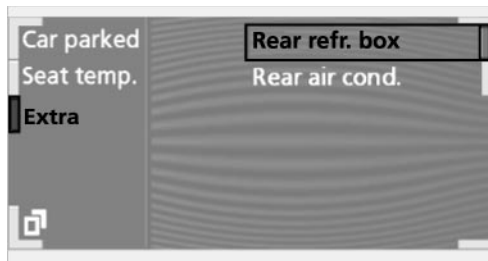

1. With the ignition on, select the Control Center "Climate" menu
2. Select the second page of the "Climate" menu
3. Select "Extra" and confirm your selection
4. Select "Rear refr. box" and confirm.

Select "Rear refr. box" a second time and confirm to switch the unit off.

To open

Pull the handle, see arrow 2

Glove compartment

To open

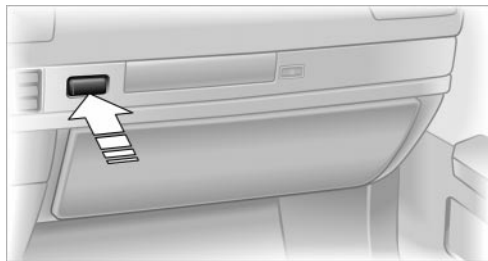

Press button. The glove compartment opens automatically and the lamps come on.

To close

Fold the cover up.

To prevent injury in the event of an accident, close the glove compartment immediately after use. ◀

Rechargeable flashlight

The flashlight is located on the left-hand side of the glove compartment. It features integral overload protection, so it can be left in its holder continuously.

 Be sure that the flashlight is switched off when it is inserted into its holder. Failure to comply with this precaution could lead to overcharging and damage. ◀

Storage compartments

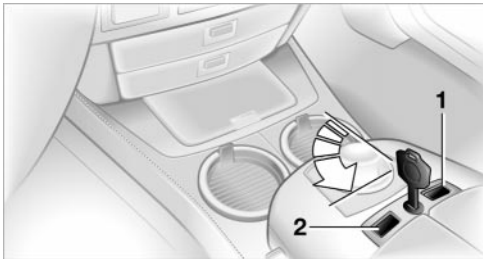

MN009096CMAA

A storage compartment is located in the armrest between the front seats.

- 1 Open the right-side cover
- 2 Open the left-side cover

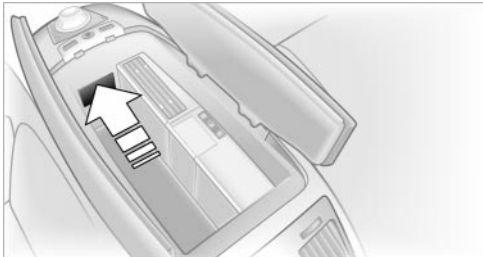

MN01234CMAA

A removable coin holder is provided in the front of the compartment. Press briefly to open.

The mat within the compartment can be removed for cleaning.

Depending upon your model specification, any of the following may be located in the storage compartment:

- ▷ Removable cassette holder*
- ▷ Removable CD holder*

▷ Fold-out and removable storage compartment* for glasses or mobile phone, etc.

▷ Fold-out and removable litter container*.

To lock storage compartment in armrest

You can use the key to lock the storage compartment in the armrest.

 You can lock the luggage compartment and the armrest storage compartment separately, and then retain the key in your possession while handing over only the remote control unit when leaving the vehicle for valet parking, etc., refer to pages 39 and 34; this prevents unauthorized access to the luggage and front storage compartments. ◀

To ventilate storage compartment in the front armrest

You can use the serrated knob in the storage compartment to open and close the vent.

 Depending on the automatic climate control setting, the temperature within the storage compartment may be higher than in the rest of the interior. Close the vent as required. ◀

Storage compartment on center console between the front seats

Open by pressing the recess on the cover.

Glasses compartment



MN00756CMAA

To open compartment:
Briefly press the button.

You can remove the insert tray for cleaning.

Storage compartment in center console



MM01122CMA

To open compartment:
Briefly press the button.

Clothes hooks

⚠ When suspending clothing from the hooks ensure that it will not obstruct the driver's vision. Do not hang heavy objects on the hooks. If you do so, they could cause personal injury during braking or evasive maneuvers. ◀

Beverage holders

Front



MM00754CMA

Below the sliding covers, see arrows.

▶ When the vehicle is parked you can rest cups, etc., on the closed sliding covers. ◀

Rear



MM00975CMA

In the front of the rear seat cushion's center.

Press briefly to open, see arrow, slide back to close.

Ashtray, front

To open

Slide back the cover by the recess.

To extinguish a cigarette, tap off the ash and gently press the tip into the funnel.

To empty

Press the button, see arrow 1. The ashtray rises for removal.



MM00907CMA

Cigarette lighter, front



Push down.

Remove as soon as the lighter jumps back out.

⚠ Hold or touch the hot cigarette lighter by the knob only. Holding or touching it in other areas could result in burns. The cigarette lighter is also ready for operation when the remote control is unlocked. For this reason, do not leave unsupervised children in the vehicle. ◀

Lighter socket

The socket can be used to plug in hand-lamps, car vacuum cleaners, etc., with power ratings of up to approx. 200W at 12V. Avoid damaging the socket due to inserting plugs of different shapes or sizes.

Power socket



An additional power socket is located in the front passenger's footwell. It is suitable for connecting radar detectors, etc. Comply with all applicable local and state laws.

To gain access, fold the cover cap up.

Ashtray, rear

To empty



Press the entire cover down. The ashtray rises for removal.

Cigarette lighter, rear



Refer to Cigarette lighter, front.

Center armrest

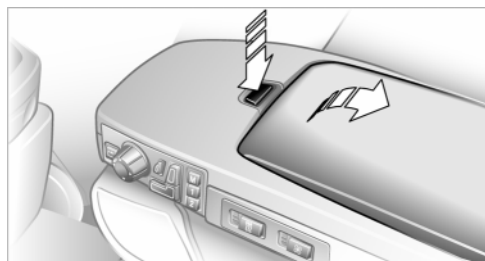

▶ Before folding down the armrest adjust the head restraint to its lowest position, refer to page 48. ◀

To open the storage compartment: Press the button and fold up the cover.

Ski bag*

Designed for safe, convenient transport of up to 4 pairs of standard skis or up to 2 snowboards.

The ski bag itself plus the additional capacity provided by the luggage compartment make it possible to transport skis with a length of up to 6.9 ft (2.10 m). When skis of 6.9 ft (2.10 m) in length are loaded the ski bag will tend to contract, reducing its overall capacity.

Loading

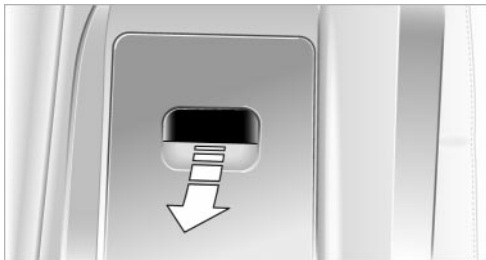

1. Fold down the center armrest, open the cover and lay it down on the armrest

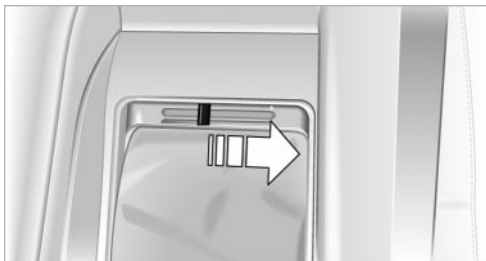

2. To open the hatch in the luggage compartment:
Press the handle and slide it to the right
 3. Extend the ski bag between the front seats. The zipper allows more convenient access to stored objects and can also be left open to allow the ski bag to dry.
- Please ensure that the skis are clean before loading them into the bag. Take care to avoid damage from sharp edges.

Securing the load

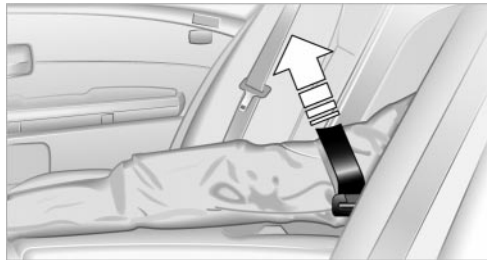

- Secure the bag's contents by tightening down the strap at the buckle. ◀

To store the ski bag

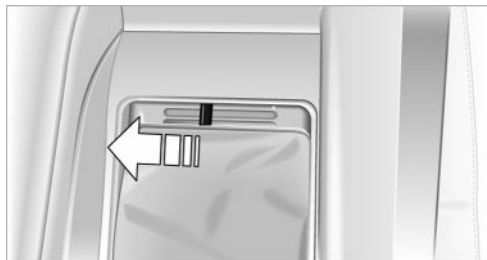

1. To close the hatch in the luggage compartment:
Press the handle and slide to the left
2. Fold up the ski bag, place it in the storage compartment and close the cover.



An aerial photograph of a winding road through a blue landscape, possibly a coastal or island setting. The road is light-colored and curves through the darker blue terrain. The sky above is filled with soft, white clouds, suggesting a bright but slightly overcast day. The overall mood is serene and scenic.

Driving tips

This section is designed to provide you with extra support by supplying information useful in dealing with specific driving and operating conditions.

Things to remember when driving

Break-in procedures

To ensure that your vehicle continues to furnish optimal economy of operation throughout an extended service life, we request that you devote careful attention to the following section.

Engine and differential

The first 1,200 miles (2,000 km): During this initial period you should attempt to avoid constant, steady-state operation and vary both vehicle and engine speeds as often as possible. Until the break-in period has been completed you should also refrain from exceeding the following:

▷ 4500 rpm and 105 mph (170 km/h)

Always obey all official speed limits.

Avoid full-throttle operation and use of the transmission's kickdown mode during these initial miles.

After the first 1,200 miles (2,000 km) you can gradually increase both engine and vehicle speeds to their respective maxima.

You should also comply with these break-in procedures if the engine or differential is replaced at a later point.

Tires

Due to technical factors associated with their manufacture, tires do not achieve their full traction potential until after an initial break-in period. We thus urge you to drive with extra care during the first 200 miles (300 kilometers).

Brake system

Brakes require an initial break-in period of approx. 300 miles (500 km) to achieve optimal contact and wear patterns between brake pads and rotors.

General driving notes

High temperatures

 Extreme temperatures occur at the catalytic converter on this and every catalyst-equipped vehicle. Do not remove the heat shields installed adjacent to various sections of the exhaust system, and never apply undercoating to them. When driving, standing at idle and while parking take care to avoid possible contact between the hot exhaust system and any highly flammable materials such as hay, leaves, grass, etc. Such contact could lead to a fire, and with it the risk of serious property damage as well as personal injury. ◀

Parking the vehicle

Condensation forms in the air conditioner system during operation, and then exits under the vehicle. Traces of condensed water under the vehicle are thus normal.

Aquaplaning

 When driving on wet or slushy roads, reduce road speed. If you do not, a wedge of water can form between tires and road surface. This phenomenon is referred to as aquaplaning, and is characterized by a partial or complete loss of contact between tires and road surface, ultimately undermining your ability to steer and brake the vehicle. ◀

Water-covered streets

 Do not drive through water on the road if it is deeper than 1 foot (30 cm), and then only at walking speed at the most. Otherwise, the vehicle's engine, the electrical systems and the transmission may be damaged. ◀

Brake system

Braking with ABS

The best way to achieve optimal response from the ABS is to apply maximum pressure to the brake pedal during emergency-panic stops. Since the vehicle maintains steering responsiveness, you can nevertheless avoid possible obstacles with a minimum of steering effort.

Pulsation at the brake pedal combines with sounds from the hydraulic circuits to indicate to the driver that ABS is in its active mode.

 Do not drive with your foot resting on the brake pedal. Even light but consistent pedal pressure can lead to high temperatures, brake wear and possibly even brake failure. ◀

Disc brakes

Driving in wet conditions

While driving in wet conditions and in heavy rain, it is a good idea to apply light pressure to the brake pedal every few miles. Monitor traffic conditions to ensure that this maneuver does not endanger other road users. The heat generated in this process helps dry the pads and rotors to ensure that full braking efficiency will then be available when you need it.

Hills

You can retain full and unimpaired braking efficiency by downshifting to a gear in which only minimal brake applications are needed when descending long or steep downhill stretches.

You can further enhance the engine's braking effect by selecting a lower gear in the automatic transmission's manual mode, downshifting as far as first gear on extremely steep stretches, refer to page 68. This strategy helps you avoid placing excessive loads on the brake system.

Corrosion

When the vehicle is driven only occasionally, during extended periods when the vehicle is not used at all, and in operating conditions where brake applications are less frequent, there is an increased tendency for corrosion to form on rotors, while contaminants accumulate on the brake pads. This occurs because the minimal pressure which must be exerted by the pads during brake applications to clean the rotors is not reached.

Should corrosion form on the brake rotors, the brakes will tend to respond with a pulsating effect that even extended application will fail to cure.

 Never allow the vehicle to coast with the transmission in neutral – or with the engine switched off; there is no engine braking when the transmission is in neutral, and no power-assist for brakes and steering when the engine is not running. Never allow floor mats, carpets or any other objects to protrude into the area around the accelerator and brake pedals and obstruct their movement. ◀

Brake pads

 If the brake pad wear indicator lamp appears in the Check Control, accompanied by a text: please take careful note of the additional information in the Control Display panel.

 Warning lamp for Canadian models.

The brake pads have reached their minimum pad thickness. Have them replaced at your BMW center as soon as possible.

 For your own safety: use only brake pads that BMW has released for your particular vehicle model. Because BMW cannot assess the suitability of other brake pads for use on your vehicle, we are unable to assume continued responsibility for the vehicle's operating safety if non-approved pads are installed. ◀

Cargo loading

Stowing cargo

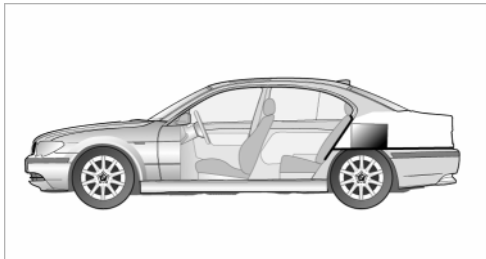

MAY009183CMA

- ▷ Load heavy cargo as far forward and as low as possible, placing it directly behind the bulkhead behind the rear seats
- ▷ Cover sharp edges and corners
- ▷ For very heavy loads when the rear seat is not occupied, secure each safety belt in the opposite buckle.

Securing the load

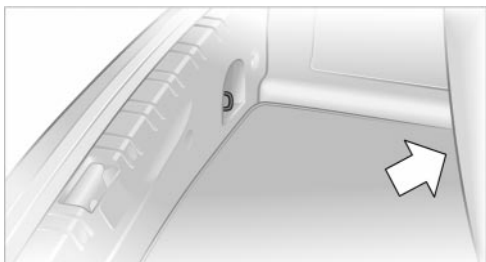

MAY007383CMA

- ▷ Use the luggage net* or securing straps to hold down small and light-weight luggage and cargo, refer to page 40
- ▷ Heavy-duty cargo straps for securing larger and heavier objects are available at your BMW center*. Anchorages for attaching these heavy-duty straps have been provided in your vehicle's luggage compartment, refer to the illustration
- ▷ Please observe the special instructions supplied with the cargo straps.

⚠ Always position and secure the load correctly. If you do not, it can endanger the passengers during braking or evasive maneuvers.
Never exceed either the approved gross

vehicle weight or either of the approved axle loads, refer to page 194, as excessive loads can pose a safety hazard, and may also place you in violation of highway safety laws.

You should never transport heavy or hard objects unsecured in the passenger compartment, as they could fly around and pose a safety hazard to the vehicle's occupants during abrupt braking or evasive maneuvers. ◀

Roof-mounted luggage rack*

Anchorage points

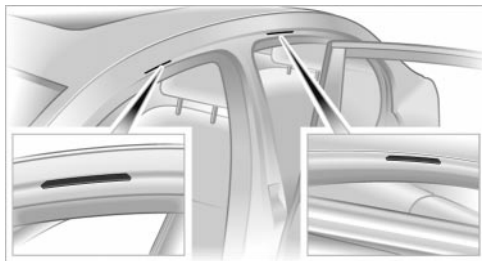

MAY009113CMA

The anchorage points are located within the door openings.

A special rack system is available as an option for your BMW. Please comply with the precautions included with the installation instructions.

Because roof racks raise the vehicle's center of gravity when loaded, they have a major effect on its handling and steering response. You should therefore always remember not to exceed the approved roof weight, the approved gross vehicle weight or the axle loads when loading the rack.

You can find the specified weights in the Technical data section on page 194.

Make sure that the load is not too heavy, and that it does not extend outward to beyond the limits of the loading surface. Always load the heaviest pieces first (on the bottom). Be sure that adequate clearance is maintained for raising the sliding/tilt sunroof, and that objects do not project

into the opening path of the luggage compartment lid.

Secure roof-mounted cargo correctly and securely to prevent it from shifting or being lost during the trip.

Drive smoothly. Avoid sudden acceleration and braking maneuvers. Take corners gently.





Navigation

This section contains various examples that illustrate how the navigation system provides you with reliable guidance to your destination.

Navigation*

Safety

By allowing you to find your destination without having to consult conventional road maps as you drive, the navigation system makes an important contribution to traffic safety.

 Enter data only when the vehicle is stationary, and always obey all traffic regulations and road signs in the event of any contradiction between traffic or road conditions and the instructions issued by the navigation system. If you do not observe this precaution, you may be in violation of the law, and can endanger vehicle occupants and other highway users. ◀

Warning!
Use this system only when traffic conditions permit. Safe vehicle operation is the drivers responsibility. For further details see owner's manual.

ACCEPT

GPS

GPS stands for Global Positioning System. This integral component within your vehicle's navigation system relies on reference satellites to determine the precise location of your vehicle. The system operates by measuring the distance between your vehicle and a minimum of three reference satellites.

The data monitored by the vehicle's antenna and the GPS receiver are fed into the navigation system's computer. The computer then correlates the satellite positioning data with information furnished by various other in-car systems such as the ABS sensors, the inertial sensors and the CD containing the system's digital road

map to obtain a basis for its subsequent calculations.

The result: the navigation system provides you with dependable guidance to your destination.

Map CD

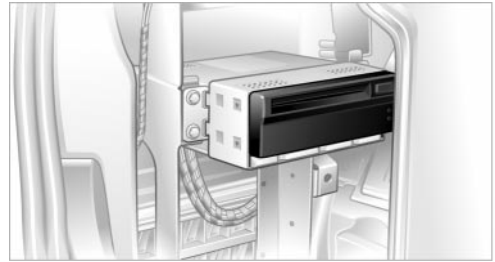

Map CDs are inserted in the navigation computer located behind the cover on the left side of the luggage compartment.

To ensure that your vehicle's navigation system has access to the latest highway network information, always load the most recent CD version of the digital road map. As is the case with conventional road maps, the map CDs are subject to periodic updates to ensure that they reflect the latest information and surveys.

 Map CDs are available at your BMW center; refer to the listing for the BMW center closest to you. ◀

Changing the map CD

As you drive, the computer will alert you when you are leaving the area stored on your current map CD; you should respond by changing the map CD in the navigation computer.

Map CDs contain road maps covering one or more countries or regions.

To change the map CD:

1. Press the button



The CD is ejected from the navigation computer

2. Remove the CD
3. Insert the new CD with the labeled side up
4. Allow eight seconds for the system to scan the data from the new CD.

Starting the navigation system

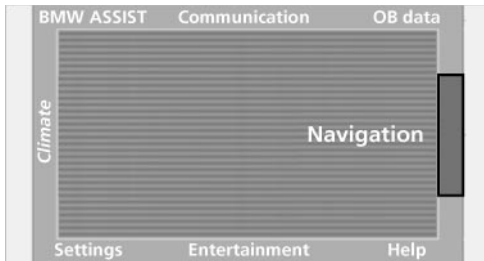
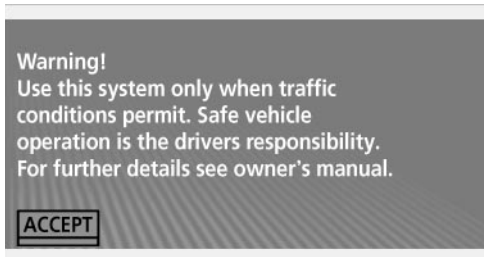

Select "Navigation."

A map will appear in the Control Display; this usually shows the area around your current position. This display will be continually updated as you drive.

When you park the vehicle before reaching the entered destination, upon restarting you will see the query "Continue route guidance?" in the Control Display.

▷ When you enter "Yes" the guidance system resumes active operation and the last selected screen content appears in the Control Display

▷ When you enter "No" the Control Display returns to the destination entry mode.

Overview

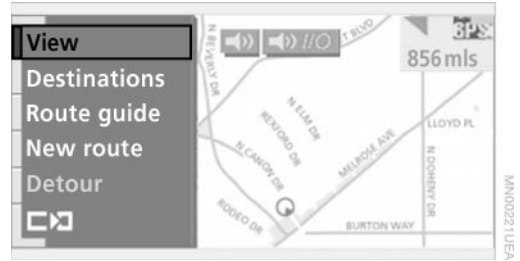

Press controller to view the menu.

▷ In the map display mode and during active guidance the menu on the left side of the screen will disappear after a few moments if no further entries are made. ◀

Display in assistance window*

You can also view the guidance system display in the assistance window; it then remains visible when you select a new menu.

▷ Select and confirm.

The following may now appear in the assistance window:

- ▷ Map direction north
- ▷ Map in travel direction
- ▷ Arrow display

The contents of the assistance window is continually updated as you drive.

To deactivate display:

1. Select "View" and confirm your selection
2. Reselect the most recent display mode and confirm your selection.

Selection options

In entering your destination you can select from among the following options:

- ▷ Manual entry of destination address, refer to next column
- ▷ To select town/city and street from the directory, refer to page 128
- ▷ To select destination with map, refer to page 128
- ▷ To select destination with Information, refer to page 129
- ▷ To select from among recent destinations, refer to page 130
- ▷ To select destination from address book, refer to page 134.

After selecting your destination you can proceed to start the guidance system, refer to page 131.

Destination entry

 Enter data only when the vehicle is stationary, and always obey the traffic regulations and road signs in the event of any contradiction between traffic and road conditions and the instructions issued by the navigation system. If you do not observe this precaution, you may be in violation of the law, and can endanger vehicle occupants and other highway users. ◀

1. Press controller, select "Destinations" and confirm your selection

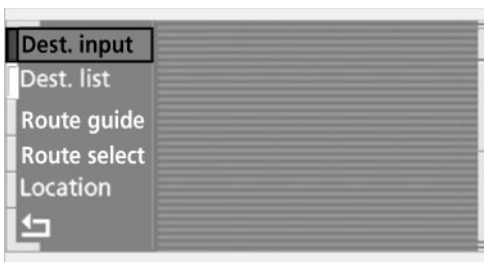

2. Select and confirm "Dest. input"

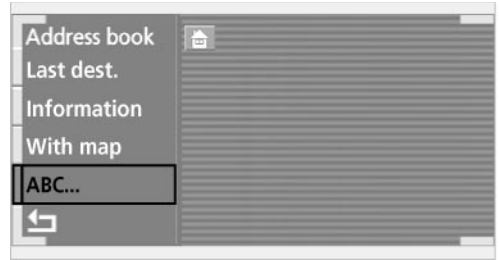

These menu selections offer you various options for entering your destination, as described in the following section.

Manual entry of destination address

The system relies on a wordmatch principle to make it easier for you to enter names. It supports various spellings as well as automatic name completion, refer to page 136.

You can enter the address of your destination with "ABC..."



- ▷ "AS DEST." selects the entered address as your destination
- ▷ The "AS ADDRESS" command can be used to store the entered address in the address book

You can store more than 50 addresses; you can then import them directly from your address book to the navigation system as travel destinations, refer to page 134.

Note the following special features:

- ▷ If you do not enter a street, the system will guide you as far as the city limits

- ▷ Depending on the data stored on your map CD, you may also be able to enter the house or building number on some streets
- ▷ You can skip the entry of country and locality if the current entries are being retained for your new destination
- ▷ You can overwrite street names if you would like to proceed to another street within the same locality.

The example shows how to use the navigation system to find the following destination:

United States
Beverly Hills, Ca
455 N Rexford Drive

To enter the destination address:
 Select and confirm "ABC...".

Enter "Name"

1. Select "Name" and confirm your selection



2. Turn to select the letters, then confirm your selections by pressing

Special characters:

- ↩ Cancel selection process
- ⏏ Space bar function
- ⬅ Delete last digit

3. Select the name shown in the lower half of the Control Display and confirm your selection.

▶ A name is not essential for guidance or when you store an address in the directory. Names are limited to 10 characters.

To select country of destination

When the name of a country appears in white letters in the Control Display, this indicates that data for more than one country are stored on the map CD.

To select the United States as your country of destination:

1. Select the displayed country name and confirm. A list of available countries appears in the display
2. Turn until "United States" is highlighted
3. Press to adopt your selection as your destination.

Enter destination



"Town/city" or the name of the locality of your last destination will now appear.

1. Select "Town/city" or the locality named in the display and confirm your selection
2. Turn until "B" is highlighted
3. Press to confirm your selection.

A directory listing localities starting with the letter "B" appears in the lower half of the Control Display. The list grows smaller each time you enter a new letter.

4. Enter "Beverly Hills" by selecting and entering the letters individually

Special characters:

- ↩ Cancel selection process
- ⏏ Space bar function
- ⬅ Delete last digit

5. Select name of locality from the directory and confirm your selection.

▶ A town or city must be entered before active guidance can start. ◀

To enter street, house number and intersection

"Street" or the name of the last street entered will appear.

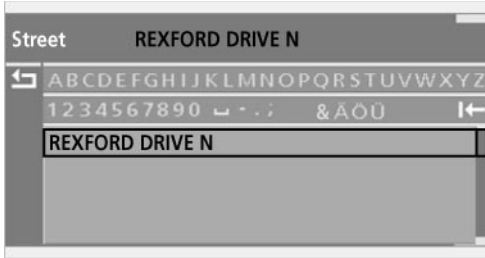



The entry procedure is the same as that used for town or city.

After entering the street you can proceed to select the house number, for instance: "455."

1. Turn until "4" is highlighted
2. Press to confirm your selection.

Use the same procedure to select all of the remaining digits in the house number.

Special characters:

-  Cancel selection process
-  Space bar function
-  Delete last digit

3. Select the number that appears in the lower half of the Control Display and confirm your selection.

 If the selected house number is not stored on the map CD, the system will adopt the nearest available number.

The option for entering house numbers will not be offered if no house numbers are stored for the selected street on your map CD. Active guidance to your destination can start immediately. ◀

The procedure for entering intersections is basically the same as that used for house numbers.

Select the town or city and the street from the directory

If you are uncertain about the precise name of the city or town, or the street, the directory can assist you in entering this information. It can show you all of the stored localities in a given country as well as all of the streets listed for any particular town or city.

The directory appears as soon as you enter a locality or street. You can obtain a more selective listing by entering one or more letters.

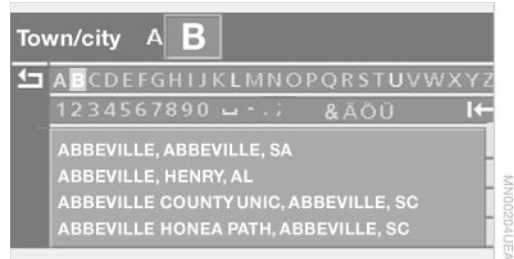

Map-guided destination selection

Assume that you only know the general location of your destination's street or locality. The system offers you maps on which you can mark your destination with a target cursor; you can then import this destination to the guidance system.

Select "With map" and confirm.

Turn the controller to adjust the scale.

Push the controller in the desired direction to localize your destination.

If no further changes are made to the map, after a brief pause the name of the street or locality marked by the cursor will appear on the screen.

Press controller to view other menu entries:



- ▷ terminates "With map" mode
 - ▷ "Next" returns to "With map"
 - ▷ Select "Location" as the map's focus again
 - ▷ The "Save dest." feature is available only in the scale ranges between 330 ft (100 m) and 0.6 miles (1 km). You can select the destination at the cursor position "AS DEST." or enter it "AS ADDRESS" in the address book. The navigation system will show the location's latitude and longitude if it is not able to determine a street. Before you can select this position "AS DEST." or enter it "AS ADDRESS" in the directory, you must first enter the name, refer to "ABC..."
 - ▷ To activate and deactivate "Information" mode. The map display will show symbols for various points of general interest according to the entered destination and the current map scale.
- You can also use the destination entry map without entering a town or city if you wish to select a destination and import it using the cursor. ◀

Selecting destination in Information

Assume that you are searching for a particular place within a town or city, such as a hotel or restaurant, a filling station, the nearest BMW center, tourist attractions, a hospital.

Select "Information" and confirm.

1. Select "On current. loc." and confirm
2. Select the desired type of destination, such as "Hotel/Motel" and confirm your selection
3. A maximum of ten destinations now appears on the right side of the Control Display. These are listed by distance to destination, while arrows also appear to indicate their directions from your current location
4. Select and confirm the destination
5. If you select
 - ▷ the address, it will be transferred to the destination list
 - ▷ to scroll the display up or down
 - ▷ the system returns to "ABC..."

Using the Voice Command system:

1. >>Navigation (menu)<< (>>Navi (menu)<<)
2. >>Information (on) location<< (>>Information (on) destination<<)
3. Enter the desired type of destination:
 - ▷ >>Hotels<<
 - ▷ >>Parking (spaces)<< (>>Parking options<<)
 - ▷ >>Gas stations<<. ◀

Selecting interesting destinations

You are looking for an interesting destination in a specific locality or country. You can obtain an overview from the map CD, which contains listings of interesting destinations in various categories.

Select "Information" and confirm.

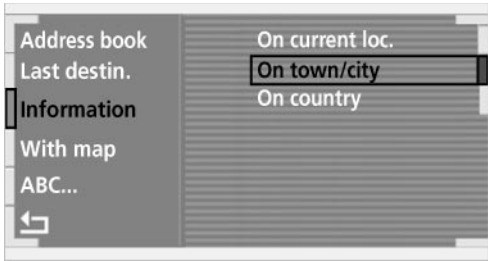

1. Select "On town/city" or "On country" and confirm. The city/town entry display appears in the Control Display
2. Enter desired town/city or country, then select "Next" and confirm
3. Select your destination category, such as "Airport" and confirm your selection. "ABC.." appears on the Control Display screen along with an alphabetical listing containing all entries in the selected destination category. You can obtain a more selective display of the information contained in the directory by entering one or more letters
4. Select the desired entry.

Recent destinations

To return to a recent destination

The system stores the last ten destinations entered.

Select "Last destin." and confirm.

A list of the stored addresses appears on the right side of the Control Display.

Confirm the desired destination and select "AS DEST." You can also edit existing entries, for instructions on how to proceed refer to "ABC...".

"AS ADDRESS" stores the destination address in the address book.

To delete all current entries:

Select  and confirm.

Destination list

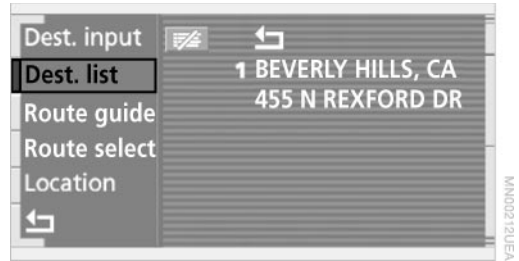

This is the most current listing of entered destinations, with the most recent destinations at the top of the list.

You can edit the entries in this list; start by selecting an entry.

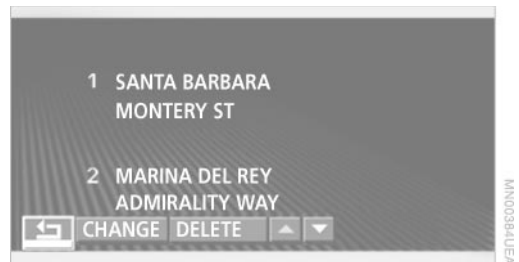

▷ Use the "CHANGE" command to enter the edit mode, refer to "ABC...." for additional instructions. The entries are stored in the address directory "AS ADDRESS" and can then be imported to the destination list with "ACCEPT".

▷ Use the "DELETE" command to delete an entry

▷ Use  to move the addresses in the destination list. You can use this feature to modify the travel route.

To delete all current entries:

Select  and confirm.

Route selection

The navigation system also provides you with the option of selecting a specific travel route. You can define priorities for determining your individual route:

- ▷ "Using motorway"

or

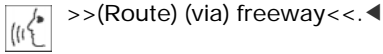

Freeways and major traffic arteries receive top priority

▷ "Avoid motorway"

or

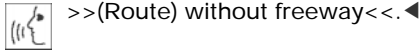

Freeways are avoided where possible

▷ "Fastest route"

or

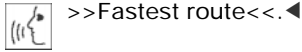

The system determines the fastest route; the selection criteria are distance, vehicle speed and potential sources of traffic congestion

▷ "Shortest route"

or



Shortest travel distance, determined without including time as a selection criterion.

▷ "Avoid tolls"

The system avoids tollways whenever possible in selecting the route (available in the near future).

You can change the selected route as often as you like, both when entering your destination and at any time while the system is guiding you to it – the system revises its travel recommendations accordingly.

1. Select "Route select" and confirm:

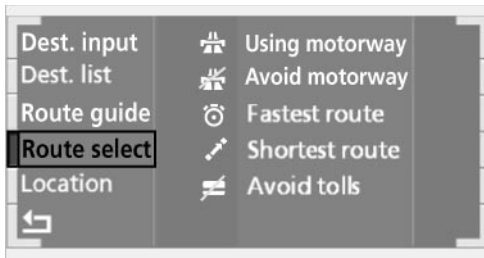

Various options are now listed on the right side of the Control Display

or

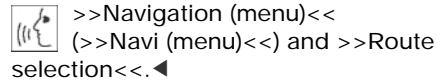

2. Select the priorities for your travel route and confirm.

The navigation system relies on specific processing criteria to determine your route. These vary according to the different kinds of roads stored on the map CD. As a result, the routes recommended by the navigation system may not always be the same ones that you would choose based on personal experience.

Starting the destination guidance system

Select "Route guide" and confirm your selection

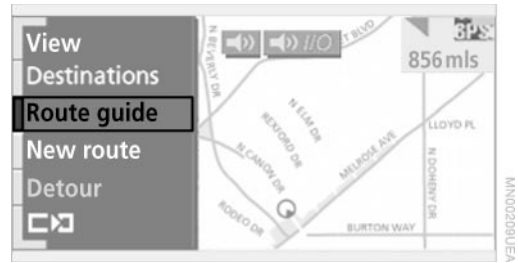

or

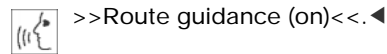

As the navigation computer determines the route to your destination, the distance and the true compass direction to your destination will appear at the upper right of the Control Display (not in all display modes).

Once the system has determined your travel route, the city or town of destination will appear in the upper right corner of the display. The system guides you in the selected display mode, refer to page 132.

The system also provides you with voice instructions.

 The system continues to guide you to your destination when you select another menu, such as "Entertainment" or "Climate control." Voice instructions will inform you of upcoming turns well before you arrive at the intersections. ◀

Displaying route

The "View" menu allows you to view your current travel route at various resolutions.





Selecting display of route map

You can also select a map showing your travel route while the system is guiding you to your destination.

1. Select and confirm "View." If you do not make any additional entries, the menu will disappear from the screen after a brief pause
2. Select "Dir. to north" and confirm your selection

or

 >>Map<<
Shows the navigation system's map. ◀

 During active guidance, the route map will appear automatically when you enter an area that is not completely covered by your map CD. ◀

To change scale

Turn the controller.
The map scale is provided at the lower right of the Control Display. You can press the controller to cancel the menu display

or

1. >>(Change) scale<<. ◀
2. Enter the desired map scale.

Altering display direction

At scales of less than 1.2 miles (2 km) you enjoy the option of deciding whether to orient the map to north or toward your current direction of travel.

1. Select and confirm "View." If you do not make any additional entries the menu will disappear from the screen after a brief pause
2. Select "Dir. of travel" or "Dir. to north" and confirm your selection.

To cancel route map

To switch to directional arrow mode:

1. Select "View" and confirm your selection. If you do not make any additional entries the menu will disappear from the screen after a brief pause
2. "Arrow display"

The display provides directional guidance in the form of an arrow on the Control Display and Info Display screens, refer to page 14.



 The arrow will follow the general course when you travel through an area for which your map CD does not provide comprehensive coverage. This feature is intended to assist you at crossroads and intersections. ◀

Display route list

You can access a listing of streets and towns on your route whenever the guidance system is active. This list is based on

the navigation system's suggested travel route.

The distances remaining to be traveled on each individual road are also displayed.

1. Select "View" and confirm your selection. If you do not make any additional entries the menu will disappear from the screen after a brief pause
2. Select "Route" and confirm.

If the system has not yet completely defined the travel route, "... " will appear in the list.

 select and confirm to cancel "Route" mode.

Select new route

During active guidance you can revise the navigation system's route recommendations to avoid particular stretches of road. Enter the number of miles (kilometers) that you want to travel before returning to the original route.

Select "New route" and confirm your selection.

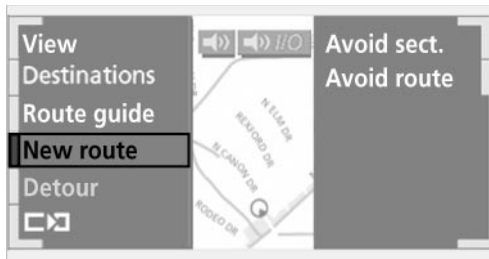

"Avoid sect.":

The route list appears in the Control Display. Select one or several connected sections of the route that you wish to avoid and confirm your selection.

You can correct erroneous entries by again selecting and confirming the stretch of the travel route to cancel its avoid status. You can also replace the avoid section by marking another stretch.

Use  to exit from the route list and calculate a new route.

"Avoid route":

You can also make a detour of up to 30 kilometers around selected sections of the calculated route. Proceed by turning the controller to confirm the desired detour mileage, then confirm your selection. To exit the "Avoid route" mode without modifying your route, enter 0 miles (kilometers) and confirm your entry.

Voice messages

To prevent the navigation system from interrupting other audio sources, such as a news program or traffic bulletin, you can deactivate the voice guidance system.

Press the controller and select the desired symbol during active guidance:

 //O Activating and deactivating voice guidance

or

 >>Message (output) on<< or >>Message (output) off<<. ◀

 To repeat most recent instructions with information on route or travel direction, regardless of whether voice guidance system is on or off

Volume adjustment

You can increase and decrease the volume of the navigation system's voice guidance relative to that of the sound system.



Wait until the voice guidance is issuing instructions, refer to page 141, then turn to select the desired volume.

The navigation system's voice guidance will continue to issue instructions at this volume level, even if the other audio accessories are set to minimum volume.

Terminate/interrupt active guidance

Select "Route guide" and confirm your selection

or

 1. >>Navigation (menu)<<
(>>Navi (menu)<<)

2. >>Route guidance off<<. ◀

The system suspends active guidance, including voice guidance, until reactivated.

Creating a directory

 You can also enter your current position in the address book after leaving the sector covered by the map CD. You must also enter a designation for the location in order to use this feature. ◀

To store addresses

To make it even easier to enter destinations, the system lets you store more than 50 addresses for frequent destinations in an address book.

Addresses can be entered from different menus.

The system stores the current address in the address book as "AS ADDRESS."

The first destination in the destination list can be stored in a special address book for the voice command system:

 1. >>Navigation (menu)<<
(>>Navi (menu)<<)

2. >>Save destination per voice<<
(>>Save destination per voice recognition<<)

3. Assign a name to the destination's map coordinates. ◀

To select an address

Select "Address book" and confirm your entry.

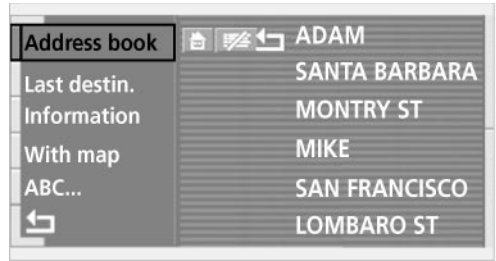

A list of the stored addresses appears on the right side of the Control Display.

To enter the desired address as a destination, select this address, then confirm your selection and select "AS DEST."

You can edit existing entries in the address book, for instructions on how to proceed refer to "ABC..."

To access the address book using the voice command system:

 1. >>Navigation (menu)<<
(>>Navi (menu)<<)

2. Select destination entry mode:

▷ >>Destination input with address book<<

You can select the destination from the Control Display or using the voice command system

▷ >>Destination input via navigation<<
(>>Destination input on screen<<)

You can select the destination on the Control Display

▷ >>Destination input by voice<<

You can select your destination using the voice command mode. ◀

Selecting destinations using voice command system:

 1. >>Select destination<<
(>>Select entry<<, >>Select name<<, >>Select destination<<)

2. Enter destination. ◀

or

 1. >>Navigation (menu)<<
(>>Navi (menu)<<)

2. >>Read out address book<<

▷ To scroll forward: >>Next<<

- ▷ To scroll back: >>Back<<
- ▷ To repeat: >>Repeat<<
- ▷ To import to destination list: >>Select<<
(>>Destination selection<<)
- 3. To delete an entry: >>Delete entry<<
(>>Delete name<<).◀

Home address

You can use  to adopt your home address as your destination.

 Select and confirm.

- ▷ "AS DEST." adopts the current home address as the destination
- ▷ You can enter and edit the home address using the "ABC..." function
- ▷ "LOCATION" imports your current location as the home address
- ▷ "AS ADDRESS" stores the entered address or current location as your home address.

Using the voice command system:

1.  >>Navigation (menu)<<
(>>Navi (menu)<<)
2. >>Route guidance to home<<.◀

To delete addresses

To delete individual entries:

1.  >>Navigation (menu)<<
(>>Navi (menu)<<)
2. >>Delete entry<<
(>>Delete name<<, >>Delete destination<<).◀
3. Select name.

To delete all current entries:

Select  and confirm your selection
or

1.  >>Navigation (menu)<<
(>>Navi (menu)<<)
2. >>Delete address book<<.◀

Location

Display of current location

1. Select "Location" and confirm.

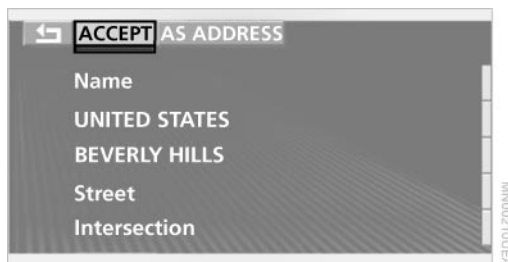

You can request the current location of your BMW or view a display showing your map location. If the navigation system is unable to identify a town or city, your current longitude and latitude will appear.

If the address is extended to include "Street" and "Intersection" (refer to "ABC..." for further instructions), this information can be adopted as the current location using "ACCEPT."

"AS ADDRESS" can be used to import your current location into the address book; you can also enter a name as desired. Entry of a name is mandatory for locations identified only by their map coordinates.

Entering the location

We recommend that you avoid entering subsequent corrections of your location unless absolutely necessary. After transport by truck or rail, etc., the GPS receiver may require several minutes to determine your current location. You can reduce the amount of time the system requires to determine your location by entering it manually.

To enter your current location:

1. Select and confirm "Location"
2. The procedure for entering your current location is the same as that used to enter your destination, refer to page 126.

 Once effective GPS reception has been established it will no longer be possible to revise your position manually.◀

Wordmatch principle

Your navigation system features a word-match system designed to make it easier for you to enter names. The system runs ongoing checks, comparing your destination entries with the data stored on the map CD as the basis for instant response. The user benefits include:

▷ When you make an entry that consists of more than one word, the system can identify the name regardless of the sequence in which you enter the individual words.

Example:

Official version:

J.F. Kennedy Square

Possible entries:

Kennedy Square J.F.

or:

Square J.F. Kennedy

▷ Names of specific locations can also vary from the official versions provided that the spelling of the entry corresponds to a standard form used in another country.

▷ When you are entering the names of cities and streets the system will complete them automatically as soon as enough letters are available to ensure unambiguous identification.

Example:

For instance, if you were searching for Iowa Ave NW in Washington, the system could identify the street as soon as you typed in the letter "o" and would proceed to complete the entry automatically

▷ The system only accepts name entries beginning with letters that are stored on the map CD. The system will not accept non-existent names and addresses.

What to do if ...

What to do if ...

▷ you request the current location of your vehicle, but do not receive a precise display?

The system is unable to receive enough

GPS signals at your current location owing to obstructions, your location is not yet available on your CD, or the system is in the process of calculating your location. Please wait and then try again later on.

▷ the GPS logo disappears from the Control Display screen?

Reception is interrupted; a building or similar obstruction may be the cause.

▷ the guidance system refuses to import an address from the destination directory as its destination?

The address is in the list, but not on the map CD currently in use. Choose an address as close as possible to the original one, using the destination entry map as required.

▷ the guidance system adopts an address without the street?

No specified center is defined for the selected locality on your CD. Enter any street, or a destination such as the railway station, etc., then start the guidance system.

▷ you want to enter an address for the guidance system, but it is not possible to select the letters for your desired entry? The address is in the list, but not on the map CD currently in use. In this case, the system will not offer you any letters to choose from. Choose an address as close as possible to the original one, using the destination entry map as required.

▷ you attempt to enter a destination address using the target cursor, but the guidance system refuses to accept your entry?

Your current scale does not offer adequate resolution. The system can only import destinations at map scales to 0.6 miles (1 km).

▷ the system stops furnishing directions on which way to turn as you approach intersections?

You are driving in an area that has not yet been completely recorded on the map CD. Instead of an arrow indicating a turn, you will see an arrow which indicates the general direction of your planned route;

or
you have left the recommended route and the system requires a few seconds to calculate a new recommended route.

▷ while the destination route map has automatically been adopted for display?
You are driving in an area that has not yet been recorded on the map CD. The guidance system cannot operate under these conditions. However, you will see the current position of your BMW in the map display to help you orient yourself.

▷ the battery has been disconnected?
It will take approx. 15 minutes for the system to resume operation.





Entertainment

This chapter is intended to assist you in deriving maximum listening pleasure from radio broadcasts, cassettes, CDs and MDs.

Sound system

Controls

The cassette deck, or CD or MD player, is installed in the instrument panel. Local user controls for these sound systems are also provided at this location. The illustration shows a CD player as an example.



MAN001112CMA

- 1 Sound system controls
 - ▷ Press: switch on/off sound systems
 - ▷ Turn: adjusting volume
- 2 CD, MD, or cassette slot
- 3 Eject CD, MD or cassette
- 4 Station scan/track search
 - ▷ Station scan
 - ▷ Tape fast-forward/reverse
 - ▷ Title search for CD, MD and cassette

Additional control options are available in the "Entertainment" menu.

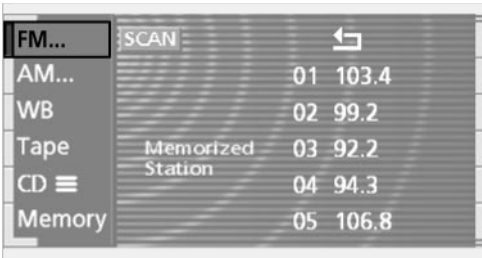

MAN004401EIA

- ▷ "FM..." and "AM..."
 - Select waveband
- ▷ "WB"
 - Select weather band
- ▷ Switches between sound systems "Tape," "CD," "MD" and **CD** ≡

- ▷ "Memory"
 - Storing a station and sound settings
 - You can also control the radio, CD and MD players, CD changer, and the cassette deck using the buttons incorporated in the steering wheel, refer to page 18 as well as via the voice command system, see page 26.

Care instructions

Comprehensive descriptions and instructions can be found in the Car Care manual.

To switch on/off



or



>>Radio (on)<< and >>Radio off<<
(>>Audio off<<). ◀

The system returns to the most recently selected sound system – radio, cassette, CD or MD.

Using with ignition off

The sound system remains available for use for a period of approx. 20 minutes after you switch off the ignition.

Switching the ignition off simultaneously switches off the sound system.

Switch on again as desired.

 It is not possible to operate the system using the control buttons in the steering wheel when the ignition is off. To avoid discharging the battery you should always switch off the sound system when leaving the vehicle. ◀

Volume adjustment

Adjusting volume



Turn adjust the desired volume level.

 The sound system automatically reverts to its mute mode whenever you use your mobile phone. ◀

Tone control

Playing audio recordings

You can choose from the following tone settings:

- ▷ Treble:
To amplify or reduce high frequencies
- ▷ Bass:
To amplify or reduce low frequencies
- ▷ Balance:
Left-to-right balance
- ▷ Fader:
Front-to-rear adjustment, high/low volume
- ▷ Reset:
This feature resets the tone settings to their standard, default settings
- ▷ Speed vol.:
Speed-sensitive volume adjustment.

 Tone settings can be made separately for each sound system, i. e., radio, CD, MD and cassette. When you then select a new sound system the system automatically adopts the stored settings. ◀

Tone adjustment

1. Select and confirm "Memory"



2. Select and confirm "Tone"
 3. Select desired tone settings
- ▷ Treble and bass



Select treble or bass. Press and turn the controller to adjust the tone

- ▷ Balance and fader

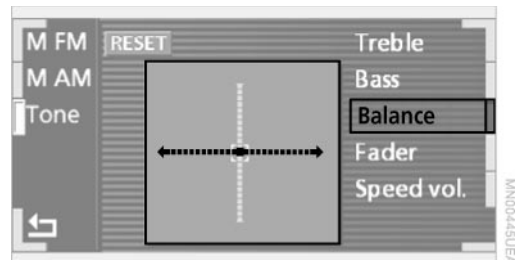

Select balance or fader. Press and turn the controller to adjust the tone

▷ "Speed vol."

Raises volume as vehicle speed increases.
Press and turn the controller to select a response level of between 1 and 6

Resetting the tone settings

You can reset all tone settings for all sound systems – radio, CD, MD or cassette – to the standard default settings.

Select and confirm "RESET."

Radio

Select the frequency band

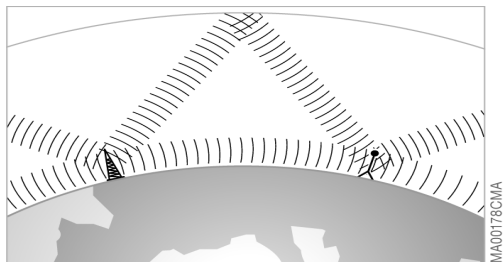

Your radio provides reception of FM and AM wavebands.

AM provides good long-range reception, as its broadcast signals are not only propagated at ground level as surface waves, but also reflected from the ionosphere as atmospheric waves.

FM furnishes substantially better acoustic quality than AM broadcasts. However, transmission range is limited, as FM relies on line-of-sight broadcast signals.

To select waveband:

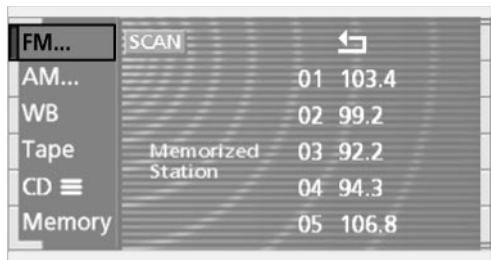

Select "FM..." or "AM..."

or

 1. >>Radio (menu)<<
2. >>FM<< or >>AM<< (>>amplitude modulation<<). ◀

 Each time you confirm "AM" the system alternately switches between the AM waveband and the "Autostore" mode.

Each time you confirm "FM" the system

alternately switches between "Memorized Station" and the "Autostore" mode. ◀

Information display

The current waveband selection appears in the Control Display, for instance, in the FM waveband:

▷ "Memorized Station"
FM waveband

▷ "03"
Number of memory location along with broadcast frequency.

The frequency of the currently selected station appears in the lower status line, refer to page 25.

Station selection

Manual station selection

To search for a particular station by selecting its frequency

To select a station



Press or maintain pressure until the desired station appears in the display

or

 1. >>Radio (menu)<<
2. >>Frequency 87 ..107 (Point 0 ..9) (megahertz)<<. ◀

Sample and select - Scan

The automatic Scan search feature automatically plays a brief sample from each station in the selected waveband.

1. Select "SCAN" in the Control Display and confirm your selection.

The unit starts its station search in the scan mode

2. To select station

Confirm "SCAN" a second time.

This cancels the scan function, and the radio remains on the current station.

Scan

To start scan:



Press briefly or maintain pressure.

The scan mode begins with the currently selected frequency.

The scan mode is stopped as soon as a station is found.

The frequency of the station appears in the bottom status line, refer to page 25.

Next station



Press to select the desired direction or

1. >>Radio (menu)<<
2. >>Next station<< or >>Station back<<. ◀

The system scans for the next station.

Storing and retrieving a station

Memory locations

Your radio can store 30 stations:

- ▷ You can store as many as 18 stations in the FM waveband
- ▷ You can store up to 12 stations in the AM waveband.

▶ Each time you confirm "AM" the system alternately switches between the AM waveband and the "Autostore" mode.

Each time you confirm "FM" the system alternately switches between "Memorized Station" and the "Autostore" mode. ◀

Storing a station

1. Select and confirm "Memory"
2. Select the waveband



"M FM" or "M AM"

Each time you confirm "AM" the system alternately switches between the AM waveband and the "Autostore" mode. Each time you confirm "FM" the system alternately switches between "Memorized Station" and the "Autostore" mode.

3. To select a station:

▷ "SCAN"

The tuner briefly samples each station in sequence, stopping at the selected station when the scan function is cancelled

▷ "MANUAL"

You can select stations manually by turning the controller

4. To store a station:

Select "Memorize" and confirm your selection

5. Select memory location

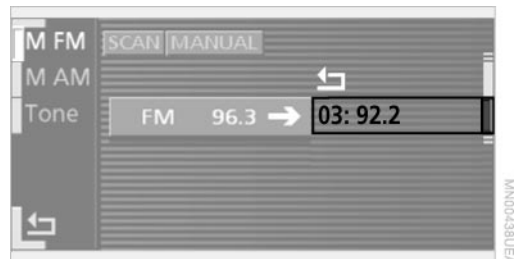

Turn the controller to select a memory location and confirm your entry.

The station is now stored.

The autostore utility's "AUTO" feature automatically selects and stores the stations

providing the best reception in the AM and FM wavebands.

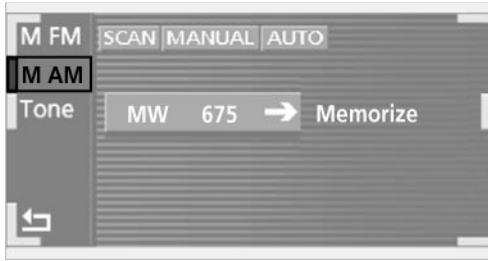

To select a stored station

1. Select the waveband

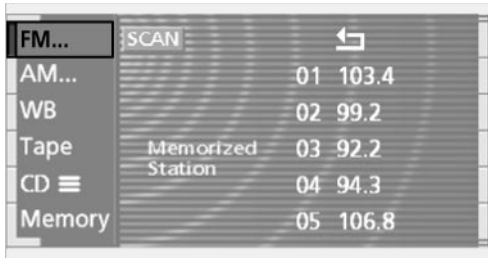

"FM" or "AM"

Each time you confirm "AM" the system alternately switches between the AM waveband and the "Autostore" mode. Each time you confirm "FM" the system alternately switches between "Memorized Station" and the "Autostore" mode.

2. Turn and press the controller to select a stored station

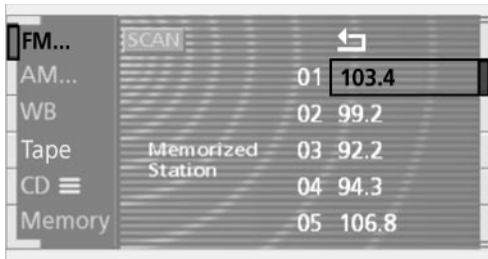

or

1. >>Radio (menu)<<
2. >>Station 1 ..12<<.◀

Weather Band

Weather Radio is a service of the National Oceanic and Atmospheric Administration – NOAA – of the U.S. Department of Commerce. Weather messages are repeated every four to six minutes and are routinely revised every one to three hours, or more frequently if needed. Most of the stations operate 24 hours daily. During severe weather, National Weather Service forecasters can interrupt the routine weather broadcasts and substitute special warning messages. If you have a question concerning NOAA Weather Radio, please contact your nearest National Weather Service Office, or write to National Weather Service – Attn: W/OM11–, National Oceanic and Atmospheric Administration, 1325 East-West Highway, Silver Spring, MD. 20910.

To select Weather Band

1. Select "WB" and confirm your selection

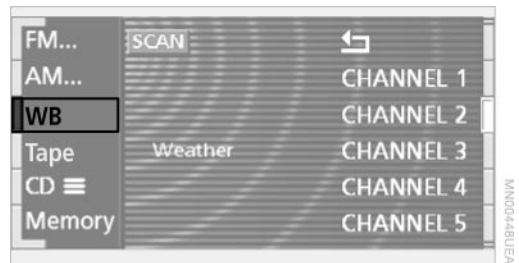

2. Turn and press to select a broadcast frequency/channel in the Weather Band.

CD Compact Disc*

 You may experience playback problems, such as skips, when using CDs that you have copied at home. ◀

Starting

Insert the CD in the slot.

If a CD is already inserted in the CD-player:
To start play



Select "CD" and confirm your selection
or

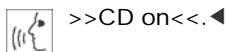

To stop play



The CD emerges slightly from the
CD player

or

switch off sound system, refer to page 140

or

switch to radio or CD player, refer to
page 140 or see above

or

1. >>CD (menu)<<
2. >>CD off<< (>>Audio off<<). ◀

Using the buttons to search for music tracks

Track search

To select a direction



Press repeatedly, continuing until you
reach the desired track
or

1. >>CD (menu)<<
2. >>(CD) Next track<< or
>>(CD) Track back<<. ◀

The CD will start play at the title selected.

Fast forward/reverse

1. To select the direction



Press and hold the button. The tracks can
be heard, but the sound is distorted.

2. To interrupt the fast forward/reverse,
release the button.

The CD will start play at the point selected.

Searching for music tracks in the Control Display

To select music track

Select music track and confirm your selection



or

1. >>CD (menu)<<
2. >>(CD) Track 1 1 ..30<<. ◀

Sample and select – Scan

The system plays a brief sample from each CD track.

1. To start sampling:
Select "SCAN" and confirm your selection
2. To select a track:
Confirm "SCAN" a second time to cancel the scan function. Play resumes at the point on the CD at which sampling was interrupted.

Random sequence – Random

The music tracks on the CD are played in a random sequence – Random.

To start random play:
Select "RND" and confirm your selection.

To cancel the random mode:
Select another function.

CD changer*

Location

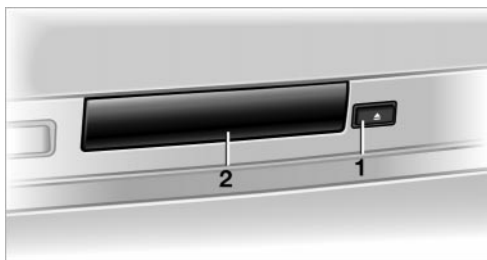

The BMW CD changer with a storage capacity of 6 CDs is installed above the glove compartment.

Removing the CD magazine

To insert or remove CDs from the storage magazine you must first remove it from the CD changer:

1. Press button 1, the panel 2 rises
2. The CD magazine is ejected and can be removed.

Loading/removing CDs from magazine



▶ When inserting and removing CDs always remember to grasp them on the edge, taking care to avoid touching the data side with its mirror finish. ◀

To load:

Insert the CD in its slot with the label side on top.

To unload:

Pull out the drawer and remove the CD, as shown in the illustration.

To insert the CD magazine

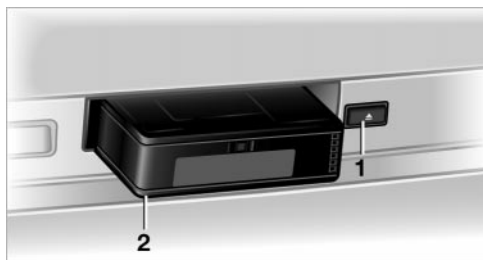

1. Press button 1, the panel rises
2. Ensure that the arrow symbol is pointing toward the CD player and slide the magazine all the way in. The cover panel closes automatically.

▶ The CD changer then automatically scans the content of all inserted CDs. After approx. 30 seconds the player is ready for operation. ◀

Operating temperatures

▶ To avoid possible malfunctions, refrain from using the CD changer at temperatures outside a range extending from +5 °F to +140 °F (-15 °C to +60 °C). Even when switched off, the unit should never be exposed to temperatures outside a range extending from -13 °F to +185 °F (-25 °C to +85 °C). ◀

Atmospheric humidity

High levels of humidity inside the unit can condense on the laser's scan lens and prevent it from reading the CD.

Precautions when using laser equipment

The BMW CD changer is a Class 1 laser product.

⚠ Never remove the cover from the housing. Do not operate the unit if the cover is damaged. Operation without the cover can lead to serious eye injury from invisible laser beams.

Always refer all repair and maintenance operations to qualified technicians. ◀

Starting and stopping the CD changer

 You may experience playback problems, such as skips, when using CDs that you have copied at home. ◀

Starting

1. Insert the CD magazine

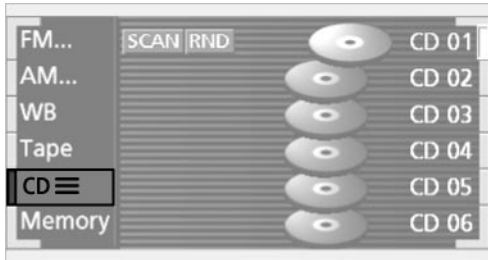

2. **CD**  Select and confirm or

 >>CD on<<. ◀

After a few seconds, play will resume at the point where the CD stopped earlier.

 After you reload the CD changer, play will automatically restart with the CD in the lowest slot loaded, for instance, CD 1, Track 1. ◀

Stopping

Switch off audio systems, refer to page 140 or

Select radio, refer to page 140, cassette, refer to page 153, MD, refer to page 151, or CD player, refer to page 146

or

1.  >>CD changer (menu)<<
2. >>CD off<< (>>Audio off<<). ◀

Status displays

The CD magazine's load status is indicated in the Control Display.

 If the display fails to detect a CD that you have loaded in the magazine, check to ensure that the CD has been inserted correctly and inspect it for signs of defects. ◀

Searching for music tracks in the Control Display

To select CD

Select a CD and confirm your entry

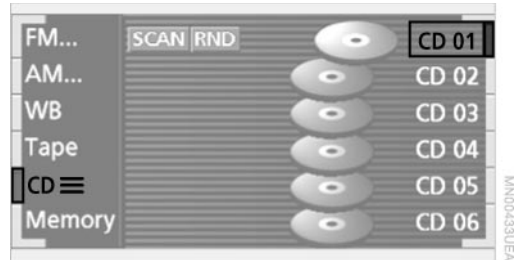

or

1.  >>CD changer (menu)<<
2. >>CD (number) 1 ..6<<. ◀

Playback starts on the first track. At the end of the last track, the next CD will be selected.

Sample and select - Scan

The system automatically plays a brief sample from each of the tracks on the current CD.

1. To start sampling:
Select "SCAN" and confirm your selection. Following the final track this CD is played starting at track 1
2. To select a track:
Confirm "SCAN" a second time to cancel the scan function. Play resumes at the point on the CD at which sampling was interrupted.

Random sequence – Random

In this mode the music tracks on the current CD are played in a random sequence – Random.

To start random play:

Select "RND" and confirm your selection.

To cancel the random mode:

Select any other function except skip track.

Using the buttons to search for music tracks

To select music track

1. >>CD changer (menu)<<
2. >>(CD) track 1 ..12<<, or >>CD (number) 1 ..12, Track 1 ..30<<. ◀

Track search

To select a direction



Press repeatedly, continuing until you reach the desired track on the current CD
or

1. >>CD changer (menu)<<
2. >>(CD) Next track<< or >>(CD) track back<<. ◀

The CD will start play at the title selected.

Fast forward/reverse

1. To select the direction



Press and hold the button. You can hear the tracks, although the sound will be distorted

2. To interrupt the fast forward/reverse, release the button.

The system will continue play at the point on the CD at which the button was released.

MiniDisc MD*

Starting

Insert the MiniDisc.

If a MiniDisc is already in the MD player:

To start play



Select "MD" and confirm your entry

or



>>Mini-Disc on<<.◀

Stopping



The MiniDisc emerges from the MD player

or

switch off sound systems, refer to page [140](#)

or

switch to radio or CD player, refer to page [140](#) or page [146](#)

or



1. >>MiniDisc (menu)<<

2. >>MiniDisc off<<

(>>Audio off<<).◀

Using the buttons to search for music tracks

Track search

To select a direction



Press repeatedly, continuing until you reach the desired track

or



1. >>MiniDisc (menu)<<

2. >>(MiniDisc) Next track<< or >>(MiniDisc) track back<<.◀

The MD will start playing at the title selected.

Fast forward/reverse

1. To select the direction



Press and hold the button. The tracks can be heard, but the sound is distorted

2. To interrupt the fast forward/reverse, release the button.

The MD will start playing at the point selected.

Searching for music tracks in the Control Display

To select music track

Select music track and confirm your selection



or



1. >>MiniDisc (menu)<<
2. >>(MiniDisc) track 1 ..30<<.◀

Sample and select – Scan

The system proceeds through the disc and briefly plays a sample from each track in succession.

1. To start sampling:
Select "SCAN" and confirm your selection.
2. To select a track:
Confirm "SCAN" a second time to cancel the scan function. Play resumes at the point on the CD at which sampling was interrupted.

Random play sequence – Random

The music tracks on the MD are played in a random sequence – Random.

- To start random play:
Select "RND" and confirm your selection.
- To cancel the random mode:
Select another function.

Cassette *

Starting

Slide the cassette all the way into the slot, ensuring that the side with the exposed tape is on the right.

If a cassette is already in the slot:

To start play

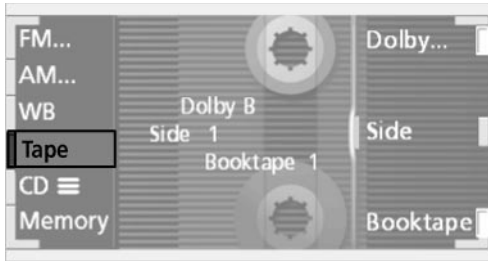

Select "Tape" and confirm your selection
or



>>Tape on<<.◀

Selecting side A or B

Select "Side" and confirm your selection
or

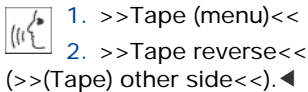

1. >>Tape (menu)<<

2. >>Tape reverse<<

(>>(Tape) other side<<).◀

Switching booktape on/off

Select "Booktape" and confirm your selection

Each time you confirm "booktape" the deck alternately switches between the two booktape tracks and the standard stereo sound track.

The selected booktape track is indicated as "Booktape 1" or "Booktape 2."

When you change tape sides with the "Side" command the deck reverts to playing the standard stereo tape.

Stopping



The cassette emerges from the slot

or

deactivate audio system, refer to page 140

or

switch to radio or CD player, refer to page 140 or page 146

or



1. >>Tape (menu)<<

2. >>Tape off<< (>>Audio off<<).◀

Noise suppression

Dolby B and C are systems designed to suppress noise and hiss during playback of audio cassettes.

It amplifies high frequencies during recording, and reduces their intensity during playback. Because background noise consists primarily of high frequencies generated during play, this strategy results in lower levels of background noise.

Dolby and the **DB** symbol are registered trademarks of the Dolby Laboratories Licensing Corporation.

To turn Dolby on/off



Activate only when playing cassettes that were recorded with Dolby B or Dolby C, as the quality of sound reproduction will otherwise suffer from a loss of high-frequency response.◀

1. Select "Tape" and confirm your selection

2. Select "Dolby..." and continue pressing until you obtain the best sound quality. The system progresses through a selection sequence of Dolby B, Dolby C and Dolby off.

The selected noise-suppression mode is indicated as "Dolby B" or "Dolby C."

Music track search

Fast forward/reverse

To select the direction



Press twice briefly or once for a longer period

or



1. >>Tape (menu)<<
2. >>(Tape) next<< or >>(Tape) back<<. ◀

When it reaches the end of the tape, the player automatically switches to the other side.

To cancel the music track search



Music search

 For the music search feature to operate, pauses of at least 4 seconds must be present between the individual music selections. ◀

To use music search



The tape is wound forward or back to the next music selection, and switches to the other track when it reaches the end of the current side.

To cancel the music search





Communications

This chapter describes the extensive array of options available for mobile communications with family, friends, business associates and service providers.

Using your mobile phone*

Safety notice

For your own safety

Your in-car phone makes life more convenient in many ways, and can even save lives in an emergency. While you should consult your mobile phone's separate manual for a detailed description of safety precautions and information, we request that you direct your particular attention to the following:

Adjustments

 To avoid posing a danger to yourself and other road users, never adjust the system settings unless your vehicle is completely stationary. ◀

Using the phone in your vehicle

 Using a hand-held mobile phone to make and receive calls while driving is now illegal in virtually every country in the world. Always use your hands-free system, or stop your vehicle in an area where you will not pose a safety hazard to other road users. ◀

Vehicles and mobile phones

 Do not use your phone from within a garage, or near an open hood. The air in these areas could contain fuel vapors, and the mobile phone might generate sparks that could result in burns. This same precaution applies to open luggage compartment lids on vehicles equipped for operation using natural gas or hydrogen, and to all vehicles with luggage compartment-mounted batteries. ◀

Antenna

 When using the phone, ensure that all persons in the area are at least 20 in (50 cm) from the antenna. Never use your BMW mobile phone if the antenna is damaged. Contact between your skin and

a damaged antenna can result in minor burns.

If the antenna is damaged, have it replaced immediately. ◀

Special environmental conditions

 Always switch off your BMW mobile phone in areas where blasting work is being conducted with explosives. The phone signals could potentially act as a high-frequency transmitter and set off explosions.

Always switch off your BMW mobile phone in areas where an increased explosion danger is present. This category includes filling stations along with fuel and chemical storage depots, etc., and all areas in which the air can contain fuel, chemicals or metal particles. Under these conditions, your BMW mobile phone could conceivably generate sparks that could lead to a fire or explosion. Always observe all legal regulations governing the use of cell phones in the vicinity of filling stations, chemical factories and other areas where an explosion potential exists.

Never use the BMW mobile phone in aircraft; do not use this mobile phone in hospitals, care centers or at other locations where medical equipment may be in operation, such as accident sites, etc.

Your service provider can furnish you with more detailed information on legal regulations governing the use of your phone. ◀

Medical equipment

 Mobile phones can generate interference capable of preventing hearing aids and cardiac pacemakers from operating correctly. If you or any occupant of the vehicle will be using such equipment, consult a physician or the manufacturer of the equipment to determine whether it is adequately shielded against high-frequency energy. ◀

Batteries

 Never attempt to open your BMW mobile phone or its battery. Use only approved battery types – the wrong battery can destroy your cell phone.

To avoid possible short circuits, after removing a battery you should never allow it to come into contact with metallic surfaces of any kind. ◀

Disposing of used batteries

 Return used batteries to a recycling collection point or to your BMW center. ◀

Care instructions

You can find everything you need to know about caring for your mobile phone in the separate "Mobile Phone" manual and in our supplementary publication on "Car care."

Operation

 For information on operating your mobile phone please consult the separate manual. ◀

You can also operate your BMW mobile phone using the

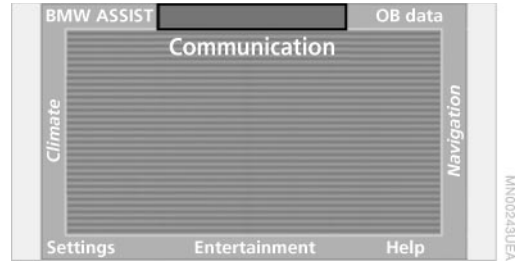

- ▷ controls on the steering wheel, refer to page 18
- ▷ Control Display
- ▷ Key Pad
- ▷ voice command system.

Control Display



The "Communication" menu provides you with access to your telephone directory, the Top 8 list and your redial list. After selecting the desired entry you can dial and establish a connection using either the button in the steering wheel or the Phone Board; the call number appears in the upper status line, refer to page 25.

You can also read messages from calls the system has received in your absence if message service is cellular provider activated.

You can alternate between the two pages of the "Communication" menu with  and .

Key Pad

The Key Pad allows you to use all of your BMW Mobile Phone's basic functions without ever picking up the receiver. Conversations are automatically routed through the hands-free system.

 The Key Pad is available for operation with the ignition switch in the radio mode and above, refer to page 61. ◀



1 Briefly press the Key Pad, it will extend automatically.

When you are done using the Key Pad, press it back in, continuing until the detent engages.

 It is not possible to remove the Key Pad. ◀

2 Press briefly: end call

Maintain pressure: switch BMW mobile phone on and off

3 Press briefly: delete the last digit entered
Maintain pressure: delete the entire number

4 Press briefly: dial or accept call

5 Enter digits 1–9



6 Symbol entry

7 Enter the digit 0





8 Press briefly: symbol entry

Maintain pressure: pause for dialling in the DTMF mode

Key Pad control buttons

Key	Function/Operation
	Press briefly: end call Extended pressure: switch BMW Mobile Phone on and off
	Incoming calls: accept call After entering phone number: establish a connection
	Press briefly: delete the last digit entered Extended pressure: delete the entire number

Key Pad digit buttons

Key	Function/Operation
 - 	Enter digits
	Enter special character #
	Enter special character *

Hands-free system

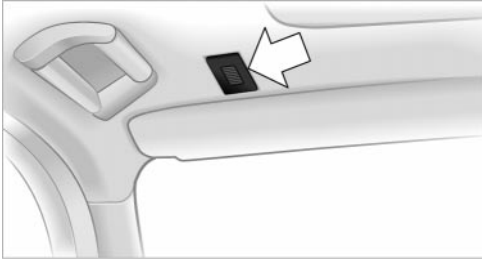

On vehicles prewired for installation of a mobile phone, the hands-free microphone is located on the front headliner.

The hands-free system is automatically activated whenever you establish or receive a call using the following:

- ▷ Button in the steering wheel
- ▷ Control Display
- ▷ Key Pad
- ▷ Voice command system.

To make SOS call



The emergency SOS call function is available only when the mobile phone receiver/handset is in its tray.

To make call manually

Maintain pressure on button, see arrow, for at least 1 second.

The system automatically triggers an emergency SOS call

- ▷ when an airbag deploys
- ▷ in response to severe rear impact

- ▷ if the vehicle rolls over.

The indicator lamp in the button flashes.

If the vehicle is not equipped with a navigation system the phone system will automatically establish contact to the standard 911 emergency number.

If the vehicle is equipped with a navigation system, the phone system will automatically establish contact with the BMW ASSIST emergency call center. The system also transmits the vehicle's current location to the center at the same time. Following transmission of the data a confirmation message will appear in the Control Display. The emergency call center can initiate immediate action for emergency assistance.

 If conditions allow, remain in the vehicle until the connection has been established. You will then be able to provide a detailed description of the situation.

If the indicator lamp flashes, but you are unable to hear the emergency call center through the hands-free system, this could indicate (for instance) that the hands-free system is no longer operational. Under these conditions you may be able to continue the call using your BMW mobile phone.

Misuse of the emergency call system is forbidden under penalty of law. ◀

Initial operation

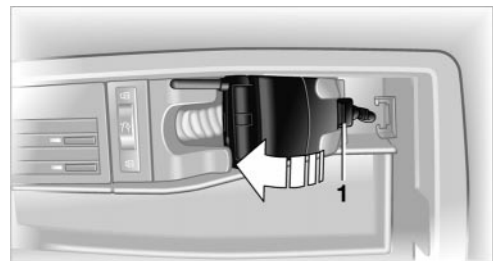

Press button 1 and insert the plug in the mobile phone.

 Before starting off place the BMW mobile phone in the tray, see arrow. You can then operate it with the in-car controls. Terminate calls using the same control feature with which the call was initiated. ◀

Getting started

Switching your BMW mobile phone on and off

 You can switch your BMW mobile phone on and off by maintaining extended pressure on the Key Pad.

Using the Voice Command system:

 >>Telephone on<<. ◀

Enter lock code

If, after switching on the telephone, you are requested by a message from the Control Display to enter the lock code:

Enter lock code, for instance 1234 .

Confirm your entry with the



key.

To place a call

Enter the desired phone number



Press.

The phone number appears in the Control Display's status line. If a number that you dialed earlier appears maintain pressure on the



button.

The new phone number can now be dialed.

Using the voice command system:

1. >>Dial (telephone) number<<
2. Enter the phone number

▷ To delete the entire number:
>>Delete (number)<< (>>Wrong<<,
>>Correction<<)

3. >>Done<< (>>Save<<, >>Dial<<). ◀

 Always remember to enter the complete telephone number, including the area code, even if you are currently in the same area as the number that you wish to contact. ◀

End call

Press



After conducting a call using the button in the steering wheel or the voice command system, you can terminate the call using the  button.

Telephone directory

You must enter your mobile phone's telephone directory in the voice command system before it will be available for access using voice commands. This creates a special voice command telephone directory. If changes are then made to the directory using the voice command system, these modifications will apply exclusively to the voice directory, and not to the directory in the mobile phone.

Creating and updating voice command telephone directory

1. >>Telephone (menu)<<
2. >>Load telephone book<< (>>Update telephone book<<). ◀

The entries in the mobile phone's telephone directory appear sequentially in the Info Display.

You must assign a specific name to each number that you wish to transfer to the voice command telephone directory. These numbers will no longer be requested during updates.

To make a new entry in the voice command telephone directory

Using the voice command system:

1. >>Save name<<
2. Enter name and repeat entry upon request
3. Enter phone numbers
4. >>Save<<.◀

Dialing from phone directory

1. Select "Communication"







▷ Select "A-Z" and confirm
An alphabetical listing of the entries in the phone directory appears on the right side of the Control Display

▷ Select "1,2,3" and confirm
The entries in the telephone directory appear on the right side of the Control Display.

2. After selecting the desired entry you can dial and establish a connection using the button in the steering wheel or the Key Pad, the phone number appears in the upper status line, refer to page 25.

 Depending upon which version of the BMW mobile phone you have, it may be possible to store several phone numbers under each entry. The following symbols are used to identify the phone numbers in the Control Display:

 home,  office,  mobile phone,  fax,  pager.◀

Using the voice command system:

1. >>Select name<<
2. Enter name.◀

The system dials the number.

To view entries

Using the voice command system:

 >>Read out (telephone book)<<

▷ To scroll forward:
>>Next entry<< (>>Next name<<, >>Entry next<<, >>Name next<<)

▷ To scroll back:
>>Previous entry<< (>>Previous name<<, >>Entry back<<, >>Name back<<)

▷ To repeat entry:
>>Once again<<

▷ To call:
>>Dial (name)<<.◀

To delete individual entries

Using the voice command system:

1. >>Telephone (menu)<<
2. >>Delete name<<
(>>Delete entry<<)
3. Enter name.◀

Deleting the entire telephone directory

Using the voice command system:

1. >>Telephone (menu)<<
2. >>Delete telephone book<<.◀

To select a number from the Top 8 list

The eight numbers that you call most frequently are automatically stored in the Top 8 list. The number called most often appears at the top of the list.

1. Select "Top 8" from the "Communication" menu and confirm your selection

2. Select an entry from the list that now appears in the display, and confirm your selection

3. After selecting the desired entry you can dial and establish a connection using the button in the steering wheel or the Key Pad, the phone number appears in the upper status line, refer to page 25.

Redialing, including numbers not initially reached

Both numbers that you reached on your earlier attempt and numbers that were unavailable are automatically stored in your redialing list. The last number dialed is at the top of the list.

1. Select "Communication"



2. Select and confirm "Last"
3. Select an entry from the list that now appears in the display, and confirm your selection
4. After selecting the desired entry you can dial and establish a connection using the button in the steering wheel or the Key Pad, the phone number appears in the upper status line, refer to page [25](#).

You can use the voice command system to redial the last number called:



Missed calls

Provided that the phone numbers have been received by the system, you can also request a display of all calls registered in your absence if this feature is cellular provider activated.

1. Select "Communication"



2. Select and confirm "Missed"
3. Select an entry from the list that now appears in the display, and confirm your selection.
4. After selecting the desired entry you can dial and establish a connection using the button in the steering wheel or the Key Pad, the phone number appears in the upper status line, refer to page [25](#).





Mobility

This section helps you maintain your mobility by supplying important information on vital topics including fuels and lubricants, wheels and tires, service, maintenance and how to deal with any problems that may occur.

Refueling

Fuel filler door



MAN007130CMA

⚠ Always switch off the engine before refueling. If you do not, fuel cannot be filled into the tank and a message in the Check Control will appear. ◀

To open and close: press the rear edge of the fuel filler door.

Manual release

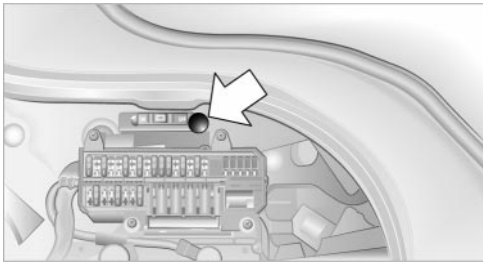

MAN01100CMA

In the event of an electrical defect in the system, you can release the fuel filler door manually:

1. Lift the handle to remove the cover panel on the right side of the luggage compartment
2. Extract and then pull the handle with the fuel pump symbol.

⚠ Always observe all applicable precautions and regulations when handling fuels. Never carry spare fuel containers in your vehicle. Whether empty or full, these containers can leak, cause an explosion, and lead to fire in the event of a collision. ◀

Simple and environmentally friendly

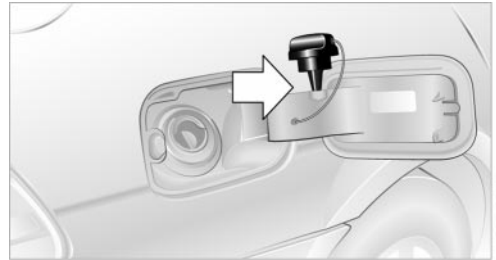

MAN00714CMA

⚠ When handling fuels always observe any safety guidelines posted at the filling station. ◀

Keep the filler cap in the bracket attached to the fuel filler door.

When refueling, insert the filler nozzle completely into the filler pipe. Pulling the nozzle out of the pipe during refueling

▷ results in premature pump shutoff

▷ can lead to reduced efficiency in the fuel-vapor recovery system.

The fuel tank is full when the filler nozzle clicks off the first time.

⚠ Close the filler cap carefully after refueling, continuing until you hear the detent engage. While closing, be sure not to pinch the strap between the cap and the filler pipe. A loose or missing cap will activate a message in the Check Control. ◀

Fuel tank capacity, approx. 23.2 US gallons (88 litres), including the reserve capacity of approx. 2.6 gallons (10 litres).

⚠ Never attempt to continue driving until the tank is completely empty, as engine functions could be affected, and the vehicle could sustain damage as a result. ◀

Fuel specifications

The engine uses lead-free gasoline only.

Required fuel:

▷ Premium Unleaded Gasoline,
min. 91 AKI.

AKI = Anti-Knock Index.



Do not use leaded fuels. The use of leaded fuels will cause permanent damage to the system's oxygen sensor and the catalytic converter. ◀

Wheels and tires

Tire inflation pressure

Information for your safety

The factory-mounted radial tires have been specially selected to provide optimal performance when installed on your vehicle; if properly cared for they will furnish a combination of tremendous safety and excellent ride comfort.

It is not merely the tire's service life, but also driving comfort and – above all else – driving safety that depend on the condition of the tires and the maintenance of the specified tire pressure.

Incorrect inflation pressure is a frequent cause of tire damage. Tire inflation pressures also have a substantial effect on your BMW's handling response.

 Check tire inflation pressures regularly – at least every two weeks and before beginning a longer trip. If you fail to observe this precaution you may be driving on tires with incorrect tire pressures, a condition that can not only compromise your vehicle's stability, but also lead to tire damage and the risk of an accident. Remember to check the inflation pressure in your spare tire. Inflate the spare tire to the highest pressure specified for any tire on the vehicle. ◀

The inflation pressures, provided on a label affixed to the B-pillar, are visible when the driver's door is open.

To check tire pressures



MV00772CMA

The table on the next page provides the correct inflation pressures for cool (ambient temperature) tires in psi/kilo-pascal.

Vehicles with RDC Tire Pressure Monitor: Remember to reactivate the system after correcting your tire pressures, refer to page 92.

Comply with tire approval specifications

The inflation pressures in the table apply to tire sizes and tires from BMW-approved manufacturers. Your BMW center is familiar with these pressures. Higher pressures may be specified for tires from other manufacturers.

Tire specifications

Pressure specifications in psi/kPa

245/55 R 17, including M+S
245/50 R 18, including M+S



	32/220	35/240	35/240	42/290
Front: 245/45 R 19	32/220	-	35/240	-
Rear: 275/40 R 19	-	35/240	-	42/290
Front: 245/40 R 20	32/220	-	35/240	-
Rear: 275/35 R 20	-	35/240	-	42/290

Tire condition

Tire tread - Tire damage

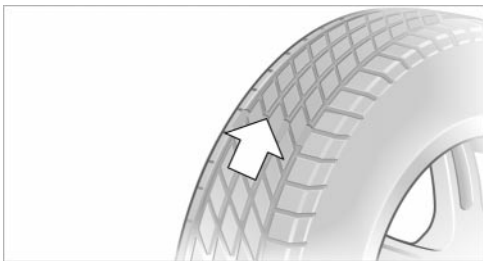

Inspect your tires frequently for tread wear, signs of damage and for foreign objects lodged in the tread. Check the tread depth.

Tread depth should not be allowed to go below 0.126 in (3 mm), even though the legally specified minimum tread depth is only 0.063 in (1.6 mm). The locations of the tread wear indicators are indicated by the letters TWI at various points on the side of the tire; when the tread wears to a depth of 0.063 in (1.6 mm), the wear indicators appear to warn you that the tread has worn to the minimum legal level. At tread depths below 0.126 in (3 mm) there is an increased risk of aquaplaning, even when only small amounts of water are present on the road surface.



Never attempt to continue driving on a flat tire. Because a flat tire will seriously impair your vehicle's handling and braking response, attempts to drive on a flat tire can lead to loss of control over the vehicle.

To avoid loading the tires beyond their approved carrying capacity, never overload the vehicle. Overloading can lead to overheating and increases the rate at which damage develops inside the tires. The ultimate result can assume the form of a sudden air loss.

Unusual vibrations during vehicle operation, of the kind that can be caused by contact with curbs, etc., may indicate that a wheel, tire or other vehicle component is damaged. These kinds of problems may also be signalled by other changes in vehicle response, such as a strong tendency to pull to the left or right. Should this occur, respond by immediately reducing your speed. Carefully proceed or have your vehicle towed to the nearest BMW center or tire dealer to have the wheels and tires inspected.

Tire damage, extending to sudden and complete loss of pressure in extreme cases, can pose a potentially lethal safety hazard for the vehicle's occupants and other road users alike. ◀

Tire replacement

To maintain good handling and vehicle response, use only tires of a single tread configuration from a single manufacturer. BMW tests and approves specific wheel and tire combinations.

DOT Quality Grades

Treadwear
Traction AA A B C
Temperature A B C

 All passenger car tires must conform to Federal Safety Requirements in addition to these grades. ◀

Treadwear

The treadwear grade is a comparative rating based on the wear rate of the tire when tested under controlled conditions on a specified government test course. For example, a tire graded 150 would wear one and one-half (1 ½) times as well on the government course as a tire graded 100. The relative performance of tires depends upon the actual conditions of their use, however, and may depart significantly from the norm due to variations in driving habits, service practices and differences in road characteristics and climate.

Traction

The traction grades, from highest to lowest, are AA, A, B, and C. Those grades represent the tire's ability to stop on wet pavement as measured under controlled conditions on specified government test surfaces of asphalt and concrete. A tire marked C may have poor traction performance.

 The traction grade assigned to this tire is based on straight-ahead braking traction tests, and does not include acceleration, cornering, hydroplaning, or peak traction characteristics. ◀

Temperature

The temperature grades are A (the highest), B, and C, representing the tire's resistance

to the generation of heat and its ability to dissipate heat when tested under controlled conditions on a specified indoor laboratory test wheel.

Sustained high temperature can cause the material of the tire to degenerate and reduce tire life, and excessive temperature can lead to sudden tire failure. The grade C corresponds to a level of performance which all passenger car tires must meet under the Federal Motor Safety Standard No. 109. Grades B and A represent higher levels of performance on the laboratory test wheel than the minimum required by law.

 The temperature grade for this tire is established for a tire that is properly inflated and not overloaded. Excessive speed, underinflation, or excessive loading, either separately or in combination, can cause heat buildup and possible tire failure. ◀

Uniform Tire Quality Grading

Quality grades can be found where applicable on the tire sidewall between tread shoulder and maximum section width. For example:

Treadwear 200 Traction AA
Temperature A

 Do not use retreaded tires, since driving safety may be impaired. Possible variations in the design and the age (which could be substantial) of the carcasses can lead to unusually rapid wear. ◀

Tire age

The tire's date of manufacture is indicated on the sidewall:

DOT ... 4901 indicates that a tire was manufactured in week 49 of the year 2001.

Regardless of mileage or wear, BMW recommends that you replace all tires – including the spare tire – after a maximum of 6 years, even though the tires may have a theoretical service life of up to 10 years.

Wheel and tire combinations

The right choice

 Use only wheel and tire combinations that BMW has approved for your particular vehicle. Variations in factors such as manufacturing tolerances mean that even wheels and tires with identical official size ratings could actually have different dimensions than the approved units. These differences could lead to body contact, and with it the risk of severe accidents. If non-approved wheels and tires are used, BMW cannot evaluate their suitability, and therefore cannot be held liable for driving safety. ◀

BMW tests certain tire brands for each tire size, classifies them as road-safe and approves them. Consult your BMW center for more information. Observe any country-specific regulations, e.g. on making a corresponding entry in the vehicle documents.

 The correct combination of wheels and tires is a vital factor in ensuring reliable operation of various vehicle systems such as ABS and DSC. It is therefore important to ensure that tires from a single manufacturer with a single tread configuration are always mounted on all vehicle wheels. After a flat tire, always remember to have the specified wheel and tire combination remounted on the vehicle as soon as possible. ◀

Storage

Always store wheels and tires in a cool, dry place with as little exposure to light as possible. Always protect tires against all contact with oil, grease and fuels.

Special characteristics of winter tires

Choosing the right tire

BMW recommends winter tires – M+S radial tires for use in cold winter driving conditions. Although all-season M+S tires provide better winter traction than standard summer tires with H, V, W and ZR speed ratings, they generally fail to provide the same levels of cold-weather performance as winter tires.

When mounting, always install winter tires of a single tread configuration and from a single manufacturer on all four wheels to ensure safe tracking and secure steering response.

Observe speed ratings

 Never exceed the maximum speed for which the tires are rated.

Unprofessional attempts by laymen to service tires can lead to damage and accidents.

Have this work performed by skilled professionals only. The technicians at your BMW center will be glad to assist you with the required professional knowledge and specialized equipment. ◀

Tire condition, tire pressure

Because winter tires display a noticeable loss in their ability to cope with cold-weather driving conditions once the tread wears to below 0.16 in (4 mm), to ensure continued safety you should always have such tires replaced.

Always maintain the specified inflation pressures in all tires, and remember to have the wheel and tire assemblies balanced every time either a wheel or a tire is replaced.

Snow chains*

BMW narrow-link snow chains are approved exclusively for use in pairs on the rear wheels, and should only be

mounted on rear tires with the dimensions 245/50 R 18. Observe the manufacturer's instructions when installing snow chains. Do not exceed a vehicle speed of 30 mph (50 km/h) with the chains mounted.

Under the hood

Hood

To release



Pull the lever located under the left side of the instrument panel.

⚠ Never attempt to perform any service or repair operations on your vehicle without the required, professional technical training. When you are unfamiliar with the service procedures and precautions, always have any required work carried out at your BMW center. Unprofessional attempts at service and repair, and the incorrect handling of parts and materials that can occur during such attempts, constitute a potential safety hazard, both for the vehicle's occupants and for other road users. ◀

To open



Pull the release handle and open the hood.

To close

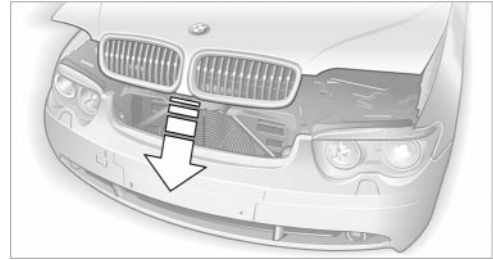

Allow the hood to fall from a height of approx. 12 in (30 cm), ensuring that you hear the detent engage securely.

⚠ Observe the same precautions that apply to all closing operations by ensuring that the hood's travel range is clear and unobstructed before allowing the hood to fall into position. If you see any signs that the hood is not completely closed while driving your vehicle, you should stop at once and close it securely. ◀

Engine compartment

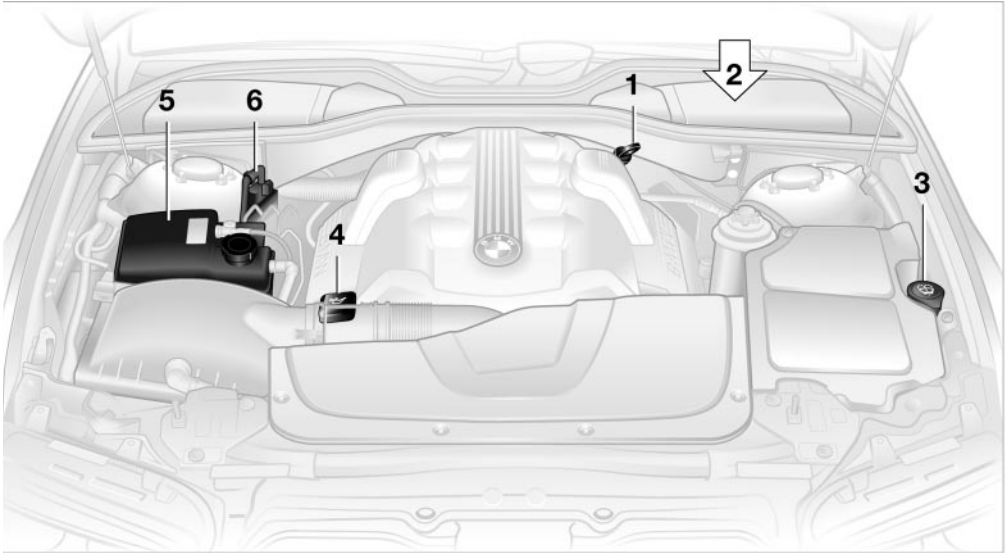

M1001748CMA

- 1 Engine oil dipstick, refer to next column
- 2 Brake fluid reservoir, located beneath the microfilter cover [178](#)
- 3 Reservoir for windshield and headlamp washer system [73](#)
- 4 Engine oil filler neck [177](#)
- 5 Coolant expansion tank [178](#)
- 6 Jump-starting terminal [187](#)

3. After approx. 5 minutes, pull the dipstick out and wipe it off with a clean lint-free cloth, paper towel, or similar material
4. Carefully push the dipstick all the way into the guide tube and pull it out again
5. The oil should extend to between the two marks on the dipstick

As is the case with fuel economy, the rate at which the engine uses oil is strongly influenced by driving style and operating conditions.

Engine oil

Checking oil level

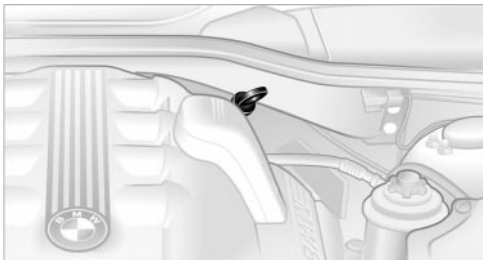

M1000912CMA

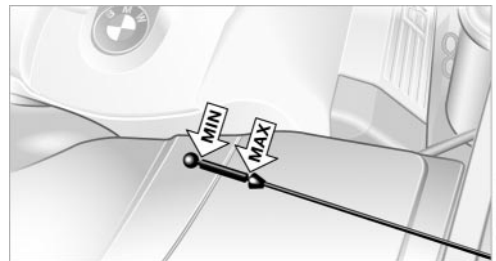

M100776CMA

1. Park the vehicle on a level surface
2. Switch the engine off after it has reached normal operating temperature

The space between the two marks on the dipstick corresponds to approx. 1.1 US quarts (1 litre). Do not fill beyond the upper mark on the dipstick. Excess oil can damage the engine.

Adding engine oil

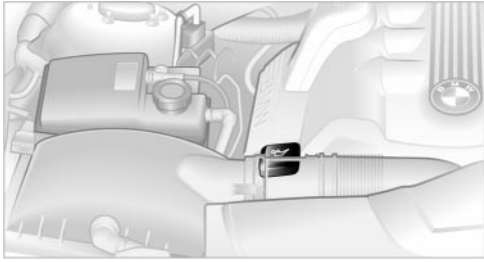

Wait until the level has dropped to just above the lower mark before adding oil.

 BMW engines are designed to operate without additives, and their use could even lead to damage in some cases. This also applies to the automatic transmission, the differential and the power steering system. ◀

Recommendation: have your oil changed at your BMW center.

 Continuous exposure to used oil has caused cancer in laboratory testing. For this reason, any skin areas that come into contact with oil should be thoroughly washed with soap and water. Always store oil, grease, etc., well out of the reach of children; always observe all warning labels on the containers. ◀

 Please observe all environmental-protection rules and regulations when disposing of used oil. ◀

Specified engine oils

The quality of the engine oil selected has critical significance for the operation and service life of an engine. BMW approves only specific oils after confirming their suitability for use in its vehicles with extensive testing.

Use only approved BMW High Performance Synthetic Oil.

If you are unable to obtain BMW High Performance Synthetic Oil, you can add small amounts of another synthetic oil between oil changes. Use only oils with the API SH specification or higher.

 Ask your BMW center for details concerning the specific BMW High Performance Synthetic Oil or synthetic oils which have been approved. ◀

You can also call BMW of North America at 1-800-831-1117 or visit this website: www.bmwusa.com to obtain this information.

Viscosity ratings

Viscosity is the oil flow rating as defined in SAE classes.

The selection of the correct SAE class depends on the climatic conditions in the area where you typically drive your BMW.

 Approved oils are in SAE classes 5W-40 and 5W-30. ◀

These oils may be used for driving in all ambient temperatures.

Coolant

 Do not add coolant to the cooling system when the engine is hot.

Escaping coolant can cause burns.

To avoid the possibility of damage later on, never use anything other than factory-approved, nitrite and amino-free extended-duty antifreeze with corrosion inhibitor. Your BMW center is familiar with the official specifications.

Antifreeze and anticorrosion agents are hazardous to health. Always store these agents in tightly-closed original containers kept well away from the reach of children. Extended-duty antifreeze with corrosion inhibitor contains ethylene glycol – a flammable substance. For this reason, do not spill antifreeze with corrosion inhibitor on hot engine parts. It could ignite and cause serious burns. ◀

 Always observe all applicable rules and regulations for environmental protection when disposing of used extended-duty antifreeze with corrosion inhibitor. ◀

Checking coolant level

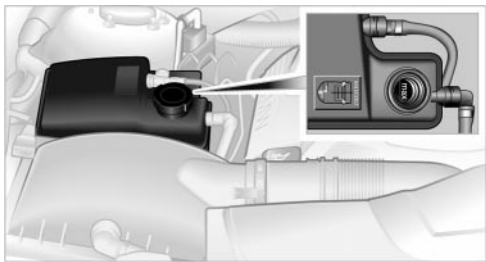

Correct coolant level with the engine cold – approx. 58 °F (20 °C):

1. Turn the cap of the expansion tank counterclockwise to allow any accumulated pressure to escape, then continue turning to open
2. The coolant level is correct when the coolant extends to between the MIN and MAX marks on the filler neck, refer to the diagram adjacent to the filler neck
3. If the coolant is low, slowly add coolant up to the specified level – do not overfill.

Brake fluid



The symbol lights up and a message appears in the Check Control panel:

The brake fluid in the reservoir has fallen to below the minimum level.

The brake fluid reservoir is located under the microfilter housing trim panel on the driver's side of the vehicle. To have brake fluid added to the system, or to have the source of any brake fluid loss traced and rectified, please contact your BMW center, which can also supply the factory-approved DOT 4 brake fluids.

 Brake fluid is hygroscopic: it absorbs moisture from the atmosphere over the course of time.

To ensure that the brake system continues to provide safe and reliable performance, remember to have the brake fluid changed every two years at the latest, refer to page 79 and to the Service and Warranty Information Booklet (US models) or the

Warranty and Service Guide Booklet (Canadian models).

Brake fluid is toxic and also damages vehicle paintwork. Always store brake fluid in tightly-closed original containers kept well away from the reach of children.

Do not spill the fluid and do not refill the brake fluid reservoir to beyond the MAX mark. Should it come into contact with hot engine components, the brake fluid could ignite and cause personal injury in the form of burns. ◀



Always observe all applicable environmental rules and regulations when disposing of used brake fluid. ◀

A low brake-fluid level combined with longer-than-usual pedal travel could be a sign that one of the brake system's hydraulic circuits has failed.



Proceed to the nearest BMW center. Remember that pedal travel may be increased, and there may also be a substantial increase in the amount of pedal pressure required to brake the vehicle. Please adapt your driving style accordingly. ◀



Warning lamp for Canadian models

Maintenance

The BMW Maintenance System

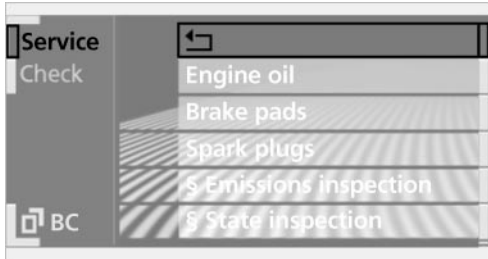

The BMW Maintenance System is designed to ensure that your vehicle will continue to furnish consistent reliability combined with optimal safety. The service schedule also includes operations related to the vehicle's comfort and convenience features, such as replacement of the filters for the inside air. The ultimate objective is to furnish economical maintenance by providing the ideal service for your individual vehicle.

Should the day come when you decide to sell your BMW, you will find that a complete dealer service history is an asset of great value.

CBS Condition Based Service

CBS is a more advanced version of the Service Interval Display. Sensors combine with highly-specialized algorithms to supply service information that reflects your vehicle's actual operating conditions more precisely than ever before.

The system now furnishes individual displays of the times remaining until the deadlines for specific service operations as well as official state inspections:

- ▷ Engine oil
- ▷ Brakes – separate for front and rear
- ▷ Microfilter/activated-charcoal filter
- ▷ Brake fluid

- ▷ Coolant
- ▷ Spark plugs
- ▷ Vehicle check
- ▷ Official state inspections

CBS monitors both current and upcoming service requirements. After accessing the data stored in the vehicle's key, your BMW service advisor is able to suggest precisely the right array of service procedures for your own individual vehicle.

By letting you define a service and maintenance regimen that reflects your own individual requirements, Condition Based Service builds the basis for troublefree driving.

You can find more detailed information on the Service Interval Display on page 78.

Service and Warranty Information Booklet (US models) and Service Guide Booklet (Canadian models)

Please consult your Service and Warranty Information Booklet (US models) and Service Guide Booklet (Canadian models) for additional information on service requirements.

▶ Have service and repair operations performed at your BMW center.

Take the time to ensure that these service procedures are confirmed by entries in your vehicle's Service and Warranty Information Booklet (US models) and Service Guide Booklet (Canadian models). These entries verify that your vehicle has received the specified regular maintenance, and may also be required when submitting warranty claims. ◀

Care

You can find everything you need to know on this topic by consulting the separate "Car care" manual.

Rules and regulations

California Proposition 65 Warning

California laws require us to state the following warning:

 Engine exhausts, some of its constituents, and certain vehicle components contain or emit chemicals known to the State of California to cause cancer and birth defects or other reproductive harm. ◀

nearest BMW center as soon as possible. Severe engine misfire over only a short period of time can seriously damage emissions control components, especially the catalytic converter.

 When the fuel filler cap is not properly tightened, the OBD system can detect the vapor leak and the indicator will light up. If the filler cap is subsequently tightened, the indicator should go out within a few days. ◀

OBD connector



The Onboard Diagnostic (OBD) interface socket is located on the left of the driver's side under the instrument panel and under a cover.

The cover has the letters OBD on it.

The purpose of the OBD system is to ensure proper operation of the emission control system for the vehicle's lifetime. The system monitors emission-related components and systems for deterioration and malfunction.

 An illuminated lamp informs you of the need for service, not of the need to stop the vehicle. However, the systems should be checked by your BMW center at the earliest possible opportunity.

Under certain conditions, the indicator will blink or flash. This indicates a rather severe level of engine misfire. When this occurs, you should reduce speed and consult the

Replacing components

Onboard tool kit



The onboard tool kit is located in the luggage compartment lid.

Loosen the wingnut to open.

Windshield wiper blades

To replace the blades, start by folding the wipers out and away from the windshield, refer to page 72.

▶ Use only wiper blades that have been approved by BMW. ◀

Lamps and bulbs

The lamps and bulbs are essential factors contributing to the safety of your vehicle. Therefore, comply fully with the following instructions during bulb replacement. If you are not familiar with the specified procedures, have the replacements carried out at your BMW center.

▶ Never touch the glass on new bulbs with your bare fingers, as even minute amounts of contamination will burn into the bulb's surface and reduce its service life. Use a clean cloth, napkin, etc., or hold the bulb by its metal socket. ◀

You can obtain a selection of replacement bulbs at your BMW center.

⚠ To prevent short circuits, before working on any electrical system, equipment or accessory you should always

switch it off and disconnect the cable from the battery's negative terminal before starting.

To avoid possible injury or equipment damage when changing bulbs, always observe any instructions provided by the bulb manufacturer. ◀

▶ When caring for your headlamps:
▶ Do not clean by wiping with a dry cloth (scratches). Never use abrasives or strong solvents to clean the covers
▶ Remove contaminants such as dead insects by soaking with BMW Shampoo and then washing off with plenty of water
▶ Remove ice by thawing with a deicer spray – never use an ice scraper. ◀

Headlamps

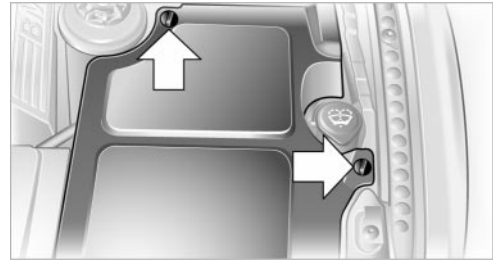

Engine compartment, left side:
Turn the quick-release clamps, see arrows, 90° counterclockwise and remove the cover.

After replacing the bulb return the cover to its original position and press the quick-release clamps down.

Release the lamp cover

The illustration shows the left-hand side of the engine compartment.

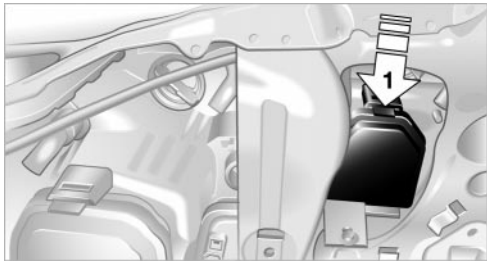

1 High beams

Press the tab down, see arrow.

! Always wear gloves and eye protection – the atmosphere within the bulb is pressurized. Failure to observe this precaution can lead to personal injury should the bulb be damaged. ◀

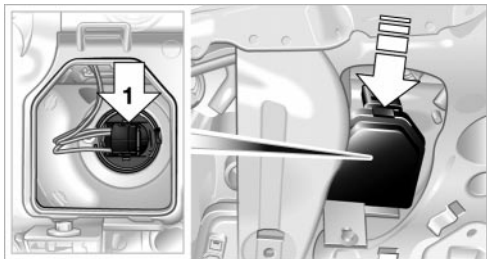

1 High beams

H7 bulb, 55 watts

1. Remove the cover
2. Turn the bulb holder to the left and remove
3. Remove and replace the bulb.

Xenon lamps

The service life of these bulbs is very long and the probability of a failure is very low, provided that they are not switched on and off an unusual number of times. In the unlikely event that one of these lamps should fail, you can respond by switching on your fog lamps and proceeding carefully (where allowed by law).

! To avoid risk of potentially fatal injuries: owing to the extremely high voltages at which these units operate, service work should always be entrusted to qualified personnel. ◀

Parking and standing lamps

In the event of a malfunction, please contact your BMW center.

Turn signal indicator, front

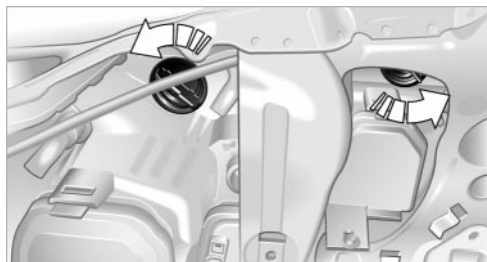

Two bulbs 21 watt – P 21 W

1. Turn the bulb holder to the left and remove
2. Apply gentle pressure to the bulb while turning it to the left for removal and replacement.

Side-mounted turn signal indicators

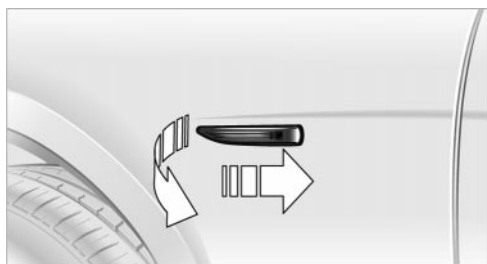

Bulb, 5 watts – W 5 W

1. Press against the front edge of the bulb with the tip of your finger, then push it to the rear and release the detent at the front
2. Turn the lamp 90° and remove
3. Turn the bulb holder to the left and remove
4. Extract the bulb for replacement.

Side marker lamps, front and rear

Please contact your BMW center for replacement.

Tail lamps

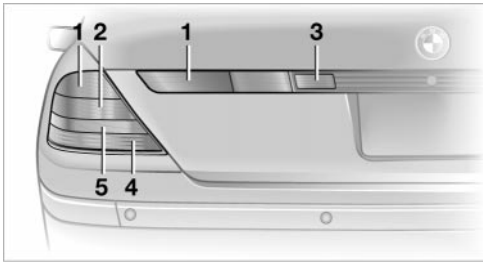

- 1 Rear lamp, red
- 2 Brake lamp, red
- 3 Backup lamp, gray or white
- 4 Turn signal indicator, yellow or white
- 5 Reflector, red

Tail lamps and brake lamps

These lamps use LED technology for operation. Please contact a BMW center in case of a malfunction.

Fender-mounted lamps



The illustration shows the recess on the left side of the luggage compartment.

Rear turn signal indicator

Bulb, 21 watts – P 21 W

1. Use the handle at the top to swivel down the side trim panel
2. Turn the bulb holder to the left and remove

3. Apply gentle pressure to the bulb while turning it to the left for removal and replacement.

Lamps in luggage compartment lid

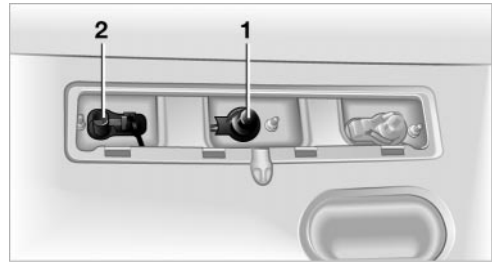

Remove the trim panel from the luggage compartment lid.

- 1 Backup lamp
- 2 License plate lamp

Replacing backup lamps and license plate lamps

Backup lamp: bulb, 16 watts – W 16 W

License plate lamp: bulb, 5 watts – W 5 W

1. Pull the bulb holder out
2. Extract the bulb for replacement.

Changing a tire

 Safety precautions to observe in the event of a flat tire and during all tire changes: park the vehicle as far as possible from passing traffic. Park on a firm, flat, surface. Switch on the hazard warning flashers.

Engage the parking brake and move the transmission's selector lever to P.

Have all vehicle occupants get out of the vehicle and ensure that they remain outside the immediate area in a safe place, such as behind a guardrail. If a warning triangle or portable hazard warning lamp is required, set it up on the roadside at an appropriate distance from the rear of the vehicle.

Comply with all safety guidelines and regulations.

Change the wheel only on a level, firm surface which is not slippery. The vehicle or

the jack could slip to the side if you attempt to raise the vehicle on a soft or slippery surface such as snow, ice, tiles, etc. Position the jack on a firm support surface. Do not use a wooden block or similar object as a support base for the jack, as this would prevent it from extending to its full support height and reduce its load-carrying capacity.

To avoid serious or fatal injury: never lie under the vehicle, and never start the engine while it is supported by the jack. ◀

What you will need

To avoid rattling noises, note the positions of the tools before removing them, then return them to their initial positions after completing work.

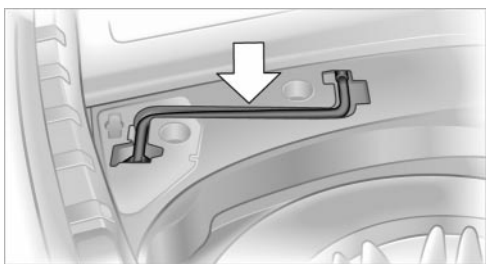

▷ Lug wrench

It is stored within the spare tire area



▷ Wheel chock

The chock is located next to the spare tire, or behind the trim panel on the left side of the luggage compartment on vehicles equipped with a trailer coupling.

Remove the floor mat and the cover above the spare tire.

Unscrew the wingnut and remove the wheel chock

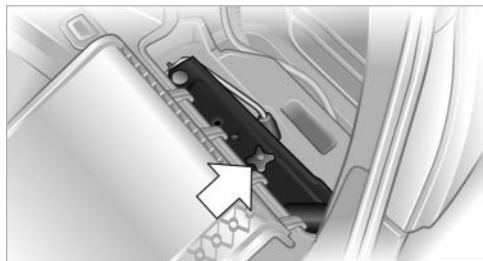

▷ Vehicle jack

The jack is located behind the side trim panel on the right side of the luggage compartment. Grasp the handle in the upper panel and fold it down.

Undo the wingnut, see arrow, and remove the jack.

After use, screw the jack all the way back down and snap the handle back into place.

Spare tire

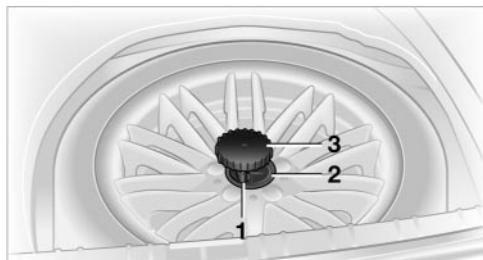

1. Undo the wingnut 1
2. Remove the disk 2 to the side
3. Unscrew the threaded rod 3 to remove it
4. Remove the wheel.

Procedure

1. Read carefully and comply with the safety precautions on page 183.
2. Secure the vehicle to prevent it from rolling: place the wheel chock against the rear surface of the front tire on the side opposite the side being raised. If the vehicle is parked on a downward slope, place the wheel chock securely in front of the tire. If the wheel must be changed on a surface with a more severe slope, take

additional precautions to secure the vehicle from rolling.

3. Loosen the lug bolts 1/2 a turn

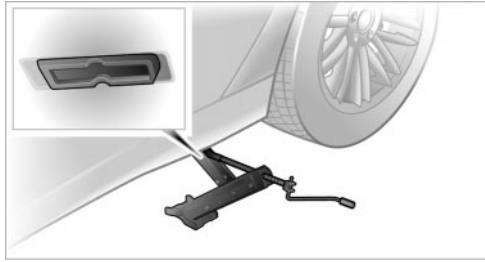

4. Set up the jack beneath the jacking point closest to the flat tire. Ensure that the entire surface of the jack's base is in firm contact with the ground and that the jack itself is standing completely vertical (not tilted), and that the fitting on the top of the jack will align with the rectangular recess on the vehicle when you raise it, refer to illustration

5. Jack the vehicle up until the wheel you are changing is raised from the ground

6. Unscrew the lug bolts and remove the wheel

7. Remove accumulations of mud or dirt from the mounting surfaces of the wheel and hub. Clean the lug bolts

8. Position the spare wheel. Secure the wheel by turning at least two lug bolts into opposite bolt holes

9. Screw in the remaining lug bolts. Tighten all the bolts securely in a diagonal pattern

10. Lower the jack and remove it from beneath the vehicle.

11. Tighten the lug bolts in a diagonal pattern

12. Check and correct the tire inflation pressure at the earliest opportunity.

 Protect valve stems and valve stem seal caps against dirt and contamination. Dirt in valve stems is a frequent source of gradual air loss.

Vehicles with RDC Tire Pressure Monitor: After mounting a spare tire or correcting

the inflation pressure(s) always remember to reinitialize the system, refer to page 92.

 The vehicle jack is designed for changing wheels only. Do not attempt to raise another vehicle model with it or to raise any load of any kind. To do so could cause accidents and personal injury. To ensure safety, always have the lug bolts checked with a calibrated torque wrench to ensure that they are tightened to the specified torque of 140 Nm as soon as possible. ◀

Reverse the removal sequence to store the wheel and tools in the vehicle.

When you mount wheels other than Original BMW light-alloy wheels, different lug bolts may also be required.

Always have damaged tires replaced and the wheel and tire assembly rebalanced at the earliest possible opportunity.

Battery

Battery care

The battery is 100% maintenance-free, i. e., the electrolyte will last for the life of the battery when the vehicle is operated in a temperate climate.

 For all questions that regard the battery, please consult your BMW center. Since the battery is maintenance-free, the following is for your information only. ◀

Charging the battery

Only charge the battery in the vehicle via the terminals in the engine compartment with the engine off. Connections, refer to Jump starting on page 187.

 To avoid short circuits, as well as possible fires and personal injury, always disconnect the cable from the battery's negative terminal before working on the vehicle's electrical system. ◀

Battery switch

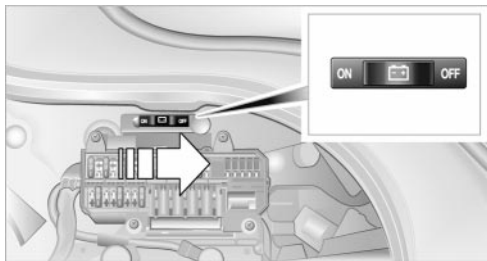

Before storing the vehicle for an extended period of several weeks or more, slide the battery switch located behind the trim panel on the right side of the luggage compartment to OFF. This reduces the current flow from the battery for the period during which the vehicle remains parked. A message appears in the Check Control panel. Please take note of the supplementary information provided in the Control Display.

⚠ Never disconnect either battery cable from its terminal while the engine is running – the resulting voltage surge would destroy the vehicle's electronic systems. ◀

 Return used batteries to a recycling point or your BMW center. Maintain the battery in an upright position for transport and storage. Always restrain the battery to prevent it from tipping over during transport. ◀

fuses and a set of tweezers are located next to the fuse strip.

⚠ Never attempt to repair a blown fuse, and do not replace a defective fuse with a substitute of another color or amperage rating, as this could lead to a circuit overload, ultimately resulting in a fire in the vehicle. ◀

In the luggage compartment

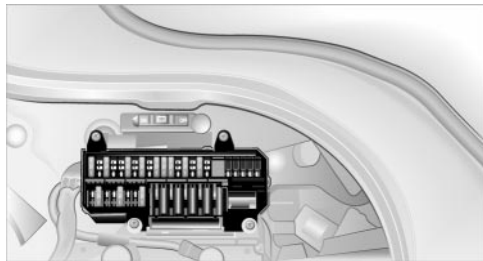

Use the handle to pull down the trim on the right wall.

Fuses

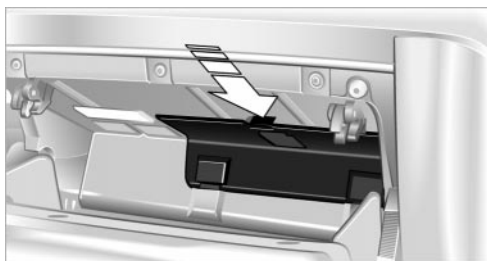

In the glove compartment

Press the tab on the cover, see arrow, to the front, then fold up the cover. Spare

Help – Giving and receiving

Warning triangle*



The warning triangle is conveniently stored in the onboard tool kit mounted on the inside of the luggage compartment lid.

 Comply with legal requirements requiring you to carry a hazard warning triangle in the vehicle. ◀

First-aid kit*

You will also find the first-aid kit in the onboard tool kit's container.

 Some of the articles contained in the first-aid kit have a limited service life. For this reason, check the expiration dates of each of the items regularly, and replace any whose expiration dates have passed. You can find replacements in any pharmacy. Always comply with laws requiring a first-aid kit to be carried in the vehicle. ◀

Jump-starting

Never use spray fluids to start the engine. When your battery is discharged you can use two jumper cables to start your vehicle with power from the battery in a second vehicle. You can also use the same method to help start another vehicle. Use only jumper cables with fully-insulated clamp handles.

 To avoid the risk of potentially fatal injury, always avoid all contact with electrical components while the engine is running. Carefully adhere to the following sequence, both to prevent damage to one or both vehicles, and to guard against possible personal injury. ◀

1. The battery in the support vehicle must also be rated at 12 volts. This information can be found on the sticker affixed to the battery
2. Switch off the support vehicle's engine and switch off all electrical equipment and accessories in both vehicles (except the hazard warning flashers on the support vehicle)
3. Ensure that no contact exists between the bodywork on the two vehicles as there is a danger of short circuits

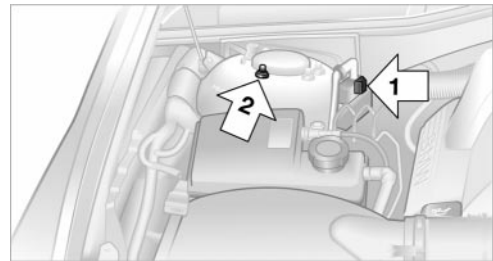

4. Your BMW is equipped with an auxiliary terminal specifically designed for jump-starting located within the engine compartment. The symbol "+" is embossed on the cover of this auxiliary terminal. Pull the cover for access to the terminal, see arrow 1 in the illustration. Start by connecting one end of a jumper cable to the positive terminal connected to the discharged battery, then connect the other end to the positive terminal of the battery on the support vehicle
5. Connect the ends of the other jumper cable to the negative terminals on both vehicles. Connect the other end to the negative battery terminal or a suitable

ground on the vehicle being started. A special nut on the strut dome, see arrow 2 in the illustration, serves as the negative terminal on your BMW

⚠ To avoid personal injury from sparks, always observe this sequence when connecting the jumper cables. ◀

6. Start the engine on the support vehicle and allow it to run for several minutes at a fast idle

7. Start the engine on the other vehicle in the usual way. If the first start attempt is not successful, wait a few minutes before another attempt in order to allow the discharged battery to recharge

8. Allow the engines to run for several minutes before disconnecting the jumper cables

9. Disconnect the jumper cables by reversing the connection sequence.

If required, have the battery inspected and recharged at your BMW center.

Towing

⚠ Even if the transmission is in perfect working order, you should always remember to disengage the transmission lockout manually before towing the vehicle. Failure to observe this precaution could result in automatic activation of the transmission lockout while the vehicle is being towed. ◀

Releasing transmission lockout manually, refer to page 70.

Tow fitting

The threaded tow fitting is stored in the tool kit mounted on the inside of the luggage compartment lid, refer to page 181, and should always remain in the vehicle. This fitting, which fits the tow sockets on both the front and the rear of the vehicle, is intended exclusively for use in towing the vehicle on paved roads.

Access to tow sockets

Press the arrow symbol to push out the cover.

Front

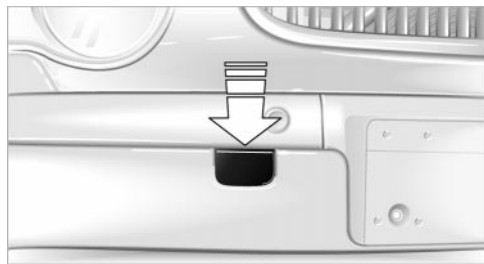

Rear

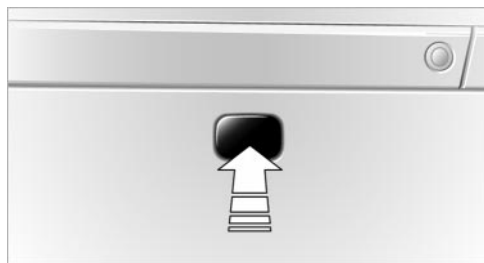

⚠ Screw the tow fitting in until it bottoms firmly. If this is not done, the threads could be damaged. Never attempt to tow or tie down the vehicle using suspension components, as this could lead to damage that might ultimately result in an accident. ◀

To avoid jerking and the associated stresses on vehicle components when towing, always use either a tow bar or a nylon rope.

▷ Keep the vehicles in line, taking care to avoid towing at an offset angle, and make certain that the tow rope connecting the two vehicles is tight before starting off. ◀

Towbars

The tow fittings used should be on the same side on both vehicles. Should it prove impossible to avoid mounting the tow bar at an offset angle, please observe the following:

- ▷ Clearance and maneuvering capability will be strictly limited in corners
- ▷ When mounted at an angle, the towbar will exert lateral forces, tending to push the vehicle sideways.

 Never use a vehicle to tow another vehicle that is heavier than itself, as this could lead to a loss of control. ◀

Towing

 Do not tow the vehicle by the rear axle; because the steering detent is not operational, the wheels could turn to an extreme angle during towing. ◀

1. Switch on the ignition to allow operation of the brake lamps, turn signal indicators, horn, parking brake and windshield wipers
2. Turn on the hazard warning flashers where allowed by law
3. Manual release of the transmission lockout, refer to page 70
4. Maximum towing speed:
maximum 43 mph (70 km/h)
5. Maximum towing distance:
maximum 93 miles (150 km).

If the electrical system in the towed vehicle has failed, use an alternate means to identify the vehicle as being towed such as a sign or warning triangle placed in the rear window.

 The steering and brakes are without power assistance when the engine is off. This means that higher levels of effort will be required to operate the steering and brakes. ◀

Tow-starting

It is not possible to start the engine by tow-starting the vehicle.

Jump starting, refer to page 187.

Have the source of the starting difficulties diagnosed and repaired at your BMW center.

Towing with a commercial tow truck

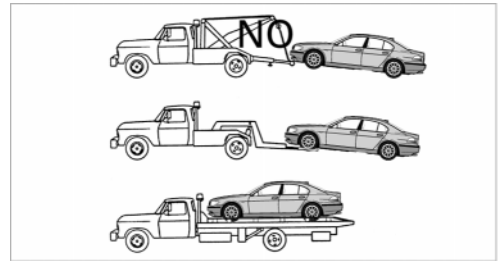

- ▷ Do not tow with sling-type equipment
- ▷ Use a wheel lift or flatbed carrier
- ▷ Please comply with applicable towing laws.

 Never allow passengers to ride in a towed vehicle for any reason. ◀



Reference

This is where to look to find information on any desired topic as quickly as possible. This chapter includes the section with technical information as well as the manual's index.

Technical data

Engine specifications

		BMW 745i, 745Li
Displacement	cu in/cm ³	268.4/4398
Number of cylinders		8
Maximum output	hp	325
at engine speed	rpm	6100
Maximum torque	lb ft/Nm	330/450
at engine speed	rpm	3600
Compression ratio	ϵ	10.5
Stroke	in/mm	3.26/82.7
Bore	in/mm	3.6/92.0
Fuel-injection system		Digital electronic engine-management system

Dimensions

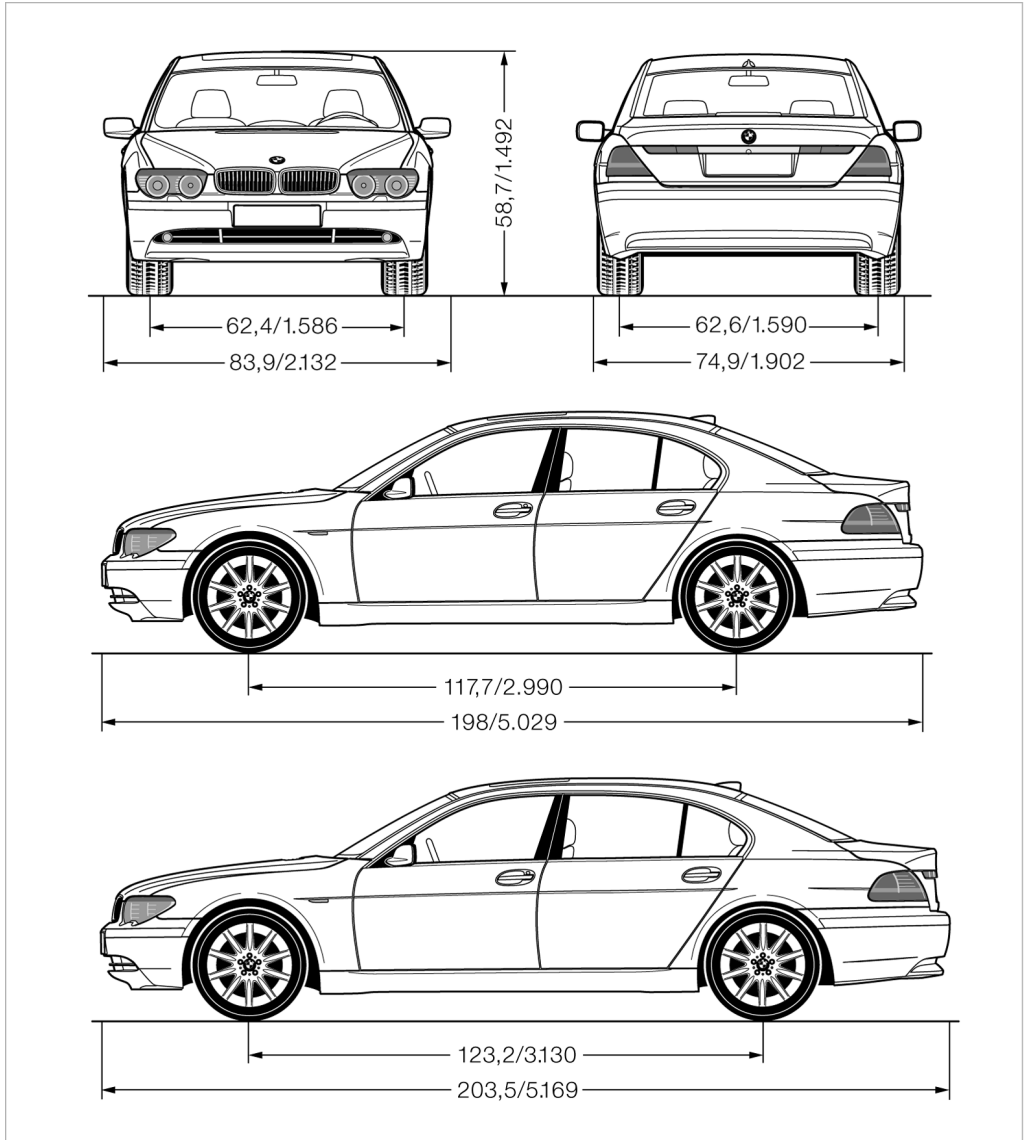

AW068210AW
AW0101280MM

All dimensions specified in inches/mm. Lower section of page: BMW 745Li.
Turning circle Ø: BMW 745i: 39.7 ft/12.1 m; BMW 745Li: 41.3 ft/12.6 m.

Weights

		BMW 745i	BMW 745Li
Vehicle curb weight: incl. one person, full tank of fuel, ready for operation, without options	lbs./kg	4376/1985	4464/2025
Approved gross vehicle load	lbs./kg	5434/2465	5523/2505
Approved front axle load	lbs./kg	2557/1160	2602/1180
Approved rear axle load	lbs./kg	2987/1355	3020/1370
Approved roof load	lbs./kg	220/100	
Luggage compartment capacity	cu ft/l	17.7/500	

Never exceed either the approved axle loads or the gross vehicle weight.

Capacities

			Notes
Fuel tank	gal./liters	approx. 23.2/88	
Reserve	gal./liters	approx. 2.6/10	Fuel specification: page 169
Windshield washer reservoir incl. headlamp wipe/wash system	quarts/liters	approx. 8.2/7.8	For details: page 73
Cooling system including heater circuit	quarts/liters	14.8/14.0	For details: page 177
Engine oil and filter change	quarts/liters	8.5/8.0	BMW High Performance Synthetic Oil Specifications: page 177
Automatic transmission and differential		-	Lifetime fluid, no fluid change required

Everything from A to Z

Contents

A

- "ABC..." for navigation [126](#), [127](#)
- ABS (Antilock Brake System) [91](#)
- "ACCEPT" for navigation [130](#)
- Accessories [8](#)
- Activated-charcoal filter [104](#)
- Activation
 - mobile phone [162](#)
- Activation time [106](#)
- Active head restraints, front [48](#)
- Active seat [52](#)
- Active seat ventilation [51](#)
- Adapter for spare key [34](#)
- Adaptive brake lamp [94](#)
- Adding oil to engine [176](#)
- Adding washer fluid [73](#)
- "Address book" [134](#)
- Adjusting thigh support [46](#)
- Airbags [55](#)
- Air distribution [100](#), [103](#)
- Airflow
 - rear air conditioner [105](#)
- Air outlet vents [99](#)
- Air pressure [170](#)
 - see also tire inflation pressure [170](#)
- Air supply [101](#)
- AKI, refer to Fuel specifications [169](#)
- Alarm system [40](#)
 - avoiding unintentional alarms [41](#)
- All-season tires [173](#)
- "AM..." [140](#), [143](#)
- AM waveband [143](#)
- Anchorage [120](#)
- Antifreeze [177](#)
 - coolant [177](#)
 - washer fluid [73](#)
- Antilock Brake System (ABS) [91](#)
- Anti-theft system [35](#)
- Approved gross vehicle weight [194](#)
- Aquaplaning [118](#), [171](#)
- Armrest, see Center armrest [113](#)
- Arrival time [83](#)
- "Arrow display" with navigation system [132](#)
- "AS ADDRESS" at current location [135](#)
- "AS ADDRESS" in address directory [134](#), [135](#)
- "AS ADDRESS" with destination list [130](#)
- "AS ADDRESS" with manual destination entry [126](#)
- "AS ADDRESS" with map-guided destination selection [129](#)
- "AS ADDRESS" with recent destinations [130](#)
- "AS DEST." with address directory [134](#)
- "AS DEST." with manual destination entry [126](#)
- "AS DEST." with map-guided destination selection [129](#)
- "AS DEST." with recent destinations [130](#)
- Ashtray
 - front [112](#)
- Assistance window, refer to Control Center [23](#)
 - help texts [23](#)
 - status lines [24](#)
- AUC (Automatic recirculated-air control) [101](#)
- Audio [140](#)
 - "AUTO," refer to Automatic climate control [103](#)
- Automatic
 - cruise control [73](#)
 - headlamp control [96](#)
 - luggage compartment lid operation [36](#), [39](#)
 - steering wheel adjustment [53](#)
- Automatic air distribution [100](#)
- Automatic climate control [99](#)
 - automatic air distribution [100](#)
 - rear air conditioner [105](#)
 - rear cooler [110](#)
 - settings in Control Display [103](#)
- Automatic curb monitor [54](#)
- Automatic Hold
 - parking [64](#)
 - parking brake [63](#)
- Automatic recirculated-air control (AUC) [101](#)
- Automatic transmission
 - with L mode [66](#)
- Automatic transmission with Steptronic [69](#)
- "Auto P" [54](#), [64](#)
- "Auxiliary heater" [106](#)
- Average fuel consumption [83](#)
- Average speed [83](#)
- Avoid false alarms [41](#)
- "Avoid motorway" [131](#)
- "Avoid route" [133](#)
- "Avoid sect." [133](#)
- "Avoid tolls" [131](#)
- Avoid unintentional alarms [41](#)
- "A-Z" [163](#)

B

- Backrest, adjusting [46](#), [47](#)
- Backrests, see Seats [45](#)

Backup lamp, bulb replacement 183
 Bass 141
 Battery 185
 – discharged 187
 Battery switch 185, 186
 "BC," refer to Computer 83
 Belts 50
 Beverage holders 112
 Blinds 109
 Blower 101
 BMW active seat 52
 "BMW ASSIST" 19, 22
 BMW comfort seat 46
 "Booktape" 153
 Brake, malfunctions 178
 Brake lamp, adaptive 94
 Brake lamps, bulb replacement 183
 "Brake pads" 179
 Brake pads 119
 Brakes 119
 Brake system
 – brake fluid 178
 Break-in procedures 118
 Brief commands for voice command system 29
 "Brief info" 23
 Bulb changes 181
 Buttons in steering wheel 18

C

California Proposition 65 Warning 180
 Call
 – terminating 162
 Calling 162
 – from telephone directory 163
 – from the redial list 164
 – from the Top 8 list 163
 – redialing 164
 Can holders, refer to Beverage holders 112
 Capacities 194
 Car care, refer to Car care manual
 Cargo, securing 120
 Cargo area
 – capacity 194
 – opening from the inside 39
 Car Memory 59
 "Car parked" 103, 106
 Car radio, see Radio 140
 Car wash, refer to separate Car care manual
 Cassette 153
 Cassette deck 153
 – booktape 153
 – fast-forward mode 154
 – music search 154
 – reverse 154
 – selecting tape side 153
 – skipping pauses 154
 – switching on 153
 CBC (Cornering Brake Control) 91
 CBS (Condition Based Service) 179
 "CD" 140, 146
 CD changer 148
 – fast forward 150
 – humidity 148
 – operating temperatures 148
 – random play 150
 – reverse 150
 – safety 148
 – scan function 149
 – skipping tracks 150
 – switching on 149
 – temperature range 148
 CD player 146
 – activation 146
 – fast forward 146
 – random selection 147
 – reverse 146
 – sampling 147
 – scan 147
 – skip track 146
 Cell phone, refer to separate Mobile phone manual 158
 Center (high-mount) brake lamp 183
 Center armrest 113
 Center console, refer to Comfort features 16
 Central locking system 35, 38
 "CHANGE" for navigation 130
 Changing bulbs 181
 Changing bulbs, refer to Lamps and bulbs 181
 Changing language 86
 Changing settings in Control Display 86
 Changing units of measure in Control Display 86
 Check Control 80
 – "Check" 81
 Checking engine oil level 176, 176
 Checking tire pressures 170
 Child-restraint systems 57
 – refer also to LATCH child-restraint system 58
 Child-safety locks 59
 Child seats 57
 Cigarette lighter 113
 Cleaning, refer to Car care manual
 "Climate" 19, 22
 "Clock" 86
 Clock 77
 – setting time and date 86
 Closing
 – from the inside 37
 Closing assist
 – doors 38
 – luggage compartment lid 39
 Cockpit 12, 16
 Coin box, see Compartments 111
 Cold start 62
 Combination switch 71
 "Comfort"
 – "EDC" 92
 Comfort features 16
 Comfort seat 46
 – in rear 47
 "Communication" 19, 22
 Compact Disc, see CD 146
 Compartments 111

Computer 81
– automatic climate control 103
– "BC" 84
– changing settings 86
– changing time and date 86
– Control Display screen contents 83
– displays, menus 22
– language selection 86
– status lines 24
– symbols 20
Computer, refer to Control Center 19
Condition Based Service (CBS) 179
Connecting car vacuum cleaner 113
Consumption display 82
Control Center 19
– assistance window 23
– automatic climate control 103
– changing menu page 20
– changing settings 86
– confirm selection or entry 20
– display help texts 23
– displays, menus 22
– language selection 86
– lists 20
– menu entry selection 19
– selecting units of measure and display format 86
– setting time and date 86
– status lines 24
– symbols 20
– symbols and lists 20
Control Display 19
Controller, refer to Control Center 19
Convenience operation of windows and sliding/tilt sunroof 36, 37
Convenience starting feature 62
"Coolant" 179
Coolant 176, 177
Cooler, refer to Rear cooler 110

Cooling adjustment
– rear air conditioner 105
Copyright 2
Cornering Brake Control (CBC) 91
Courtesy lamps 98
Cruise control 73
Cruise control, see Programmable cruise control 73
Cruising range 82
Cup holder, refer to Beverage holder 112
Curb lamp
– bulb replacement 182
Curb weight 194
Current fuel consumption 83

D

"Date" 86
Daytime driving lamp mode 96
DBC (Dynamic Brake Control) 91
Deactivating
– tilt alarm sensor 36, 41
Defrosting, windows 101
Defrost setting 101
"DELETE" for navigation 130
Destination entry 126
Destination for navigation system
– selecting in "Information" 129
Destination memory 129
"Destinations" 126
"Dest. input" 126
Dialed numbers 164
Dimensions 193
Dimming mirrors 52
Dipstick, engine oil 176
Direction
– arrow 132
– to destination 131
– voice instructions 133
Directional indicators, see Turn signal indicators 71

Directory creation
– with navigation system 134
"Dir. of travel" with navigation system 132
"Dir. to north" with navigation system 132
Disc brakes 119
Displacement 192
Display, refer to Control Display 19
Display format and units of measure in Control Display, changing 86
Display illumination, refer to Instrument lighting 97
Displays 14
– computer 22
– Control Center 22
Distance 83
Distance to destination 83
Distance warning 88
Door keys 34
Doors
– locking and unlocking 35
– manual operation 37
– remote control 35
DOT Quality Grades 172
Draft-free ventilation 102
Drink holders, refer to Beverage holders 112
Driving stability control 89
Driving tips 118
"DSC" 90
DSC (Dynamic Stability Control) 89
"DTC" 90
DTC (Dynamic Traction Control) 15, 90
Dynamic Brake Control (DBC) 91
Dynamic Drive 91
Dynamic Stability Control (DSC) 89
Dynamic Traction Control (DTC) 15, 90

E

EBV (Electronic Brake-force Distribution) 91

"EDC" 92
 – "Comfort" 92
 – "Sport" 92
 EDC (Electronic Damping Control) 92
 Electrical malfunction
 – automatic transmission
 lockout 70
 – fuel filler door 168
 – parking brake, emergency
 use 65
 – sliding/tilt sunroof 44
 Electric power seats 46
 Electric power windows 42
 Electric seats 46
 Electric steering column
 adjustment 53
 Electronic Brake-force Dis-
 tribution (EBV) 91
 Electronic Damping Control
 (EDC) 92
 Elements of operation 12
 Emergency operation
 – doors 37
 – fuel filler door 168
 – luggage compartment
 lid 40
 – sliding/tilt sunroof 44
 – transmission lockout
 (automatic
 transmission) 70
 Emergency SOS call
 – automatic activation 161
 "Emissions inspection" 79
 Energy Control 83
 Engine compartment 176
 Engine coolant 176, 177
 "Engine oil" 179
 Engine oil
 – consumption 176
 – grades 177
 Engine oils 177
 Engine output, data 192
 Engine specifications 192
 "Entertainment" 19, 22
 Estimated time of arrival 83
 Extended vehicle storage,
 see supplemental Car
 care manual
 Exterior mirrors 52
 – automatic dimming 52

"Extra" in "Climate"
 menu 103
 "Extra" with rear air
 conditioner 105
 "Extra" with rear cooler 110

F

Factory preparations for
 phone installation 161
 Fader 141
 Failure of an electrical
 accessory 186
 "Fastest route" 131
 Fastest route 131
 Fault displays 80
 Filling the washer
 reservoir 73
 Filling the windshield
 washer reservoir 73
 First-aid kit 187
 Fittings, tow-starting and
 towing 189
 Flashlight 111
 Flat tires 171
 "FM..." 140, 143
 FM waveband 143
 Fog lamps 97
 "Footwell" 103
 Footwell lamps 98
 Forward lamps 98
 Front armrest 111
 Front seat adjustment 45
 Fuel 169
 Fuel consumption
 display 83
 Fuel economy 83
 Fuel filler cap cover 168
 Fuel filler door
 – releasing in the event of
 electrical defect 168
 Fuel gauge 82
 Fuel level display 82, 83
 Fuel specifications 169
 Fuel tank capacity 168
 Fuses 186

G

Garage door opener, refer
 to Universal garage door
 opener 108
 Gasoline 169
 General operating
 information 118
 Glasses compartment 111
 Glove compartment 110
 GPS, refer to Navigation
 system 124
 GPS navigation system 124
 – address book, refer to
 Creating a directory 134
 – current location 135
 – destination entry 126
 – destination guidance in
 assistance window 125
 – destination list 130
 – digital coverage area 124
 – directory 128
 – manual entry of destina-
 tion address 126
 – map CD 124
 – map-guided destination
 selection 128
 – new route 133
 – recent destinations 130
 – route display 132
 – route list 132
 – route selection 130
 – safety 124
 – selecting destination in
 "Information" 129
 – selecting points of
 interest 129
 – selection options 126
 – start active guidance 131
 – starting 125
 – terminate/interrupt active
 guidance 134
 – voice guidance 133
 – wordmatch principle 136
 Guidance
 – terminate 134
 Guidance system
 – interrupt 134
 – starting 131

H

Handbrake, refer to Parking brake 62
Hand lamp 111
Hands-free microphone 161
Hands-free system 161
Hazard warning flashers 16
Headlamp control 96
Headlamp flasher 71
Headlamps, low beam 96
Headlamp washers 72, 73
Head restraints 48
– front head restraints, active 48
Heated steering wheel 53
Heating and ventilation 99
Heating while stopped 101
Height 193
Height adjustment
– seats 46
– steering column 53
"Help" 19, 22
Help texts in Control Display 23
High beams 97
– bulb replacement 182
High-mount brake lamp 183
Home address 135
Hood release 175
Horn 13
Hydraulic Brake Assistant, refer to DBC 91

I

Ice warning 77
Ignition key 34
Ignition lock 61
"Indep. ventil." 106
Indicator lamps 15
"Individual" 104
Individual button assignments on steering wheel 53
Inflation pressure 170
Inflation pressure control, tires 92
Info Display 14

"Information" for navigation 129
Instrument cluster, refer to Info Display 14
Instrument lighting 97
Instrument panel 12, 16
Instrument panel switch 71
Interior lamps 97
– remote control 36
Interior motion sensor 41
Interior protection
– deactivating 36, 41
Interior rearview mirror 52
– automatic dimming 52
Intermittent wipe 71

J

Jack 184
Jump-starting 187

K

Key Memory 59
Key Pad control buttons 160
Key Pad digit buttons 160
Key Pad with mobile phone 160
Keys 34
– adapter for spare key 34
Kickdown 68

L

"Last" 164
"Last destin." 130
LATCH, refer to LATCH child-restraint system 58
"Left"
– for heated seats 51
– with automatic climate control 103
Length 193
Level control system 94
License plate lamp, bulb replacement 183
Lighter 113
Lights on warning 96
Light switch 96
"Limit" 84

Limit selection, adjustment 84
Litter container 111
L mode on automatic transmission 66
Loading 120
Loading the vehicle 120
"LOCATION" 135
"Location" 129, 135
Lock Code 162
Locking
– from the outside 35
Louvers 99
Low beams
– automatic 96
Lower back support, refer to lumbar support 46
Lug bolts 185
Luggage compartment capacity 194
Luggage compartment lid
– emergency release 40
– locking separately 39
– opening from the inside 39
– opening from the outside 38
– operating via remote control 36
Luggage compartment lid operation, automatic 36, 39
Luggage compartment net 40
Luggage rack, refer to Roof-mounted luggage rack 120
Lug wrench 184
Lumbar support 46

M

M+S tires 173
Maintenance 179
Make-up mirror 53
Malfunction displays 80
"M AM" 144, 145
Manually controlled recirculated air 101

Manual operation
 – doors 37
 – sliding/tilt sunroof 44
 Manual release
 – automatic transmission lockout 70
 – fuel filler door 168
 – luggage compartment lid 40
 Manual station search 143
 Map CD 124
 "Map facing N." with navigation system 132
 Maximum axle loads 194
 Maximum roof weight 194
 Maximum speed, see Limit 84
 "MD" 140, 151
 MD player 151
 – fast forward 151
 – random play 152
 – reverse 151
 – sampling 152
 – scan function 152
 – switching on 151
 – track skip 151
 "Memo" 86
 "Memorize"
 – "Individual" 104
 Memory, refer to Seat, mirror and steering wheel memory 54
 "Memory" for audio system 140
 "Menu name" 23
 Menus
 – computer 22
 – Control Display 22
 "MFL" 53
 "M FM" 144, 145
 "Microfilter" 179
 Microfilter 104
 Microphone for hands-free system 161
 MiniDisc, refer to MD 151
 Mirrors 52
 – mirror heaters 52
 – mirror memory 54
 "Missed" 164
 Missed calls 164

Mobile phone
 – calling 162
 – call termination 162
 – controlling with the buttons on the steering wheel 18
 – emergency calls 161
 – hands-free system 161
 – missed calls 164
 – operating using the Control Display 159
 – redialing 164
 – selecting phone numbers 162
 – switching on and off 162
 – Top 8 list 163
 – using with Key Pad 160
 Mobile phone, refer to separate mobile phone manual 158
 Mobile phone battery 159
 Mobile phone codes 162
 Modifications, technical 8, 98
 Monitor, refer to Control Center 19
 Most frequently called numbers 163
 Most recent mobile phone numbers 164

N

"Navigation" 19, 22
 Navigation computer
 – installation location 124
 Navigation destination
 – manual entry 126
 – selecting with map 128
 Navigation system
 – destination list 130
 – digital coverage area 124
 – town and city centers 136
 – voice guidance 133
 Navigation system
 "ACCEPT" command 135
 Navigation system "View" function 132
 Navigation target
 cursor 128, 129
 "Navi info" 54

"New route" 133
 "Next"
 – map-guided destination selection 129
 – searching for points of interest 130
 Nozzles 99

O

"OB data" 19, 22
 OBD interface socket 180
 Occupant-restraint systems 50, 55
 Odometer 77
 Oil additives 177
 Oil change intervals, refer to Service Interval Display 78
 Oil consumption 176
 Oil dipstick 176
 Oil specifications 177
 "ON / OFF" speed limit 84
 Onboard Diagnostic (OBD) system 180
 – interface socket 180
 Onboard tool kit 181
 "On country" 130
 "On current loc." 129
 "1,2,3" 163
 "On town/city" 130
 Opening and closing
 – from the inside 37
 – from the outside 37
 Oral note 27
 Orientation
 – changing the display 132
 Orientation menu 19
 Orientation to north 132
 Outside temperature display 77

P

Paint and finish care, refer to Car care manual
 Panic mode 36
 Park Distance Control (PDC) 88
 Parked-car ventilation 106
 Parking aid 88

Parking brake [62](#)
– Automatic Hold [63](#)
– manual operation [65](#)
Parking brake lockout, refer to Transmission lockout [67](#), [70](#)
Parking lamps [96](#)
– bulb replacement [182](#)
Parking with Automatic Hold [64](#)
Passenger-side mirror tilt function [54](#)
PDC (Park Distance Control) [88](#)
"PDC pic." [88](#)
Phone directory [162](#)
– deleting all entries [163](#)
– dialing numbers using voice command system [163](#)
– entering numbers in voice command directory [163](#)
– entry deletion [163](#)
– viewing entries [163](#)
Phone number, see Mobile phone [162](#)
Please fasten safety belts warning lamp [50](#)
Pollen [104](#)
Power electric seat [47](#)
Power rating [192](#)
Power socket [113](#)
Pressure, tires [170](#)
Pressure control, tires [92](#)
Programmable cruise control [73](#)
Programming settings, refer to Car Memory, Key Memory [59](#)
Publishers [2](#)

R

Radio
– autostore [144](#)
– memory locations [144](#)
– search [144](#)
– station search [144](#)
– station selection [145](#)
– switching on and off [140](#)
– waveband selection [143](#)
– Weather Band [145](#)
Radio "Autostore" feature [144](#)
Radio mode [61](#)
Radio "SCAN" feature [143](#), [144](#)
Rain sensor [72](#)
"RDC" [93](#)
RDC (Tire Pressure Monitor) [92](#)
Reading lamps [98](#)
Rear air conditioner [105](#)
– activation and deactivation in Control Display [105](#)
– air supply [105](#)
– cooling adjustment [105](#)
– deactivating [105](#)
Rear armrest, see Center armrest [113](#)
Rear cooler [110](#)
Rear seat heaters [51](#)
Rear seats
– adjusting passenger seat from the rear [47](#)
– comfort seat adjustments [47](#)
– head restraint adjustment [48](#)
Rearview mirror [52](#)
Rear window blind, see Sun blind [109](#)
Rear window defroster [16](#)
Rear window safety switch [13](#)
"Recirc. air" [53](#)
Reclining seat [45](#)
Redialing with mobile phone [164](#)
Redial list [164](#)

Refrigerator box, refer to Rear cooler [110](#)
Refueling [168](#)
Releasing the hood [175](#)
Remaining distance [83](#)
Remote control [34](#), [35](#)
Remote-control unit [34](#)
Removing condensation from windows [101](#)
Replacement fuses [186](#)
Replacement keys [35](#)
Replacing tires [172](#)
Reserve warning [82](#)
Reservoir, washer system [73](#)
Reset [141](#)
Residual heat [101](#)
"Right"
– for heated seats [51](#)
– with automatic climate control [103](#)
"RND" with CD changer [150](#)
"RND" with CD player [147](#)
"RND" with MD player [152](#)
Roadside assistance calls
– manual activation [161](#)
Roof-mounted luggage rack [120](#)
Route
– display [132](#)
– list [132](#)
– map cancelation [132](#)
– map display [132](#)
– selection [130](#)
"Route guide" [131](#), [134](#)
"Route select" [131](#)

S

Safety belts [50](#)
Safety belt tensioners, see Safety belts [50](#)
Safety lock buttons [38](#)
Safety precautions to observe when using your phone [158](#)
Safety switch for rear windows [42](#)

- Sampling
 - CD changer [149](#)
 - MD player [152](#)
- Satellite [124](#)
- Scan
 - CD player [147](#)
 - MiniDisc [152](#)
 - radio [143](#)
- Scan, station sampling
 - radio [143](#)
- Scan audio sampling
 - CD [147](#)
- Scan mode
 - radio [144](#)
- "SCAN" with CD changer [149](#)
- "SCAN" with CD player [147](#)
- "SCAN" with MD player [152](#)
- Seat heating [50](#)
- Seat memory [54](#)
- Seats
 - adjusting [45](#)
 - correct position [45](#)
- "Seat temp." [51](#), [103](#)
- Seat ventilation, see Active seat ventilation [51](#)
- Securing cargo, see Cargo [120](#)
- Securing the load [114](#)
- Selecting new route with navigation system [133](#)
- Selecting new scale for navigation system display [132](#)
- Selecting stored radio stations [145](#)
- Selector lever, automatic transmission [67](#)
- Select "Route" [133](#)
- "Service" [78](#), [179](#)
 - "Emissions inspection" [79](#)
 - "Spark plugs" [78](#)
 - "State inspection" [79](#)
- Service and Warranty Information Booklet (US models) [179](#)
- Service brakes [119](#)
- Service Guide Booklet (Canadian models) [179](#)
- Service Interval
 - Display [78](#), [179](#)
- Service Requirement Display, see Service Interval Display [179](#)
- "SET", refer to Setting speed limit [84](#)
- Set time [106](#)
- "Settings" [19](#), [22](#)
- Setting time and date [86](#)
- Shifting, refer to Automatic transmission with
 - Steptronic [69](#)
- Shiftlock [67](#)
- "Shortest route" [131](#)
- Shortest travel distance [131](#)
- Shoulder support [46](#)
- "Side" in sound system operation [153](#)
- Side window blind, see Sun blinds [109](#)
- Sitting correctly [45](#)
- Ski bag [114](#)
- Sliding/tilt sunroof [43](#)
 - closing in the event of an electrical defect [44](#)
 - convenience mode [37](#)
- Snow chains [173](#), [174](#)
- Soft Close Automatic
 - doors [38](#)
 - luggage compartment lid [39](#)
- SOS call
 - using SOS button [161](#)
- Sound system
 - switching on and off [140](#)
 - volume [141](#)
- Sound system adjustments
 - balance [141](#)
 - bass [141](#)
 - default settings [142](#)
 - fader, front/rear [141](#)
 - left/right [141](#)
 - treble [141](#)
- Sound system "AUTO" function [145](#)
- Sound system "Balance" adjustment [141](#)
- Sound system "Bass" adjustment [141](#)
- Sound system "Dolby..." feature [153](#)
- Sound system "Fader" adjustment [141](#)
- Sound system "MANUAL" selection mode [144](#)
- Sound system "Memorize" feature [144](#)
- Sound system "Memory" feature [141](#), [144](#)
- Sound system "Reset" function [142](#)
- Sound system "Speed Vol." feature [142](#)
- Spare fuses [186](#)
- Spare key [34](#)
 - adapter [34](#)
- Spare tire [184](#)
- "Spark plugs" [78](#), [179](#)
- Specifications for engine oil [177](#)
- Speed limit
 - "Limit" [84](#)
- Speed limit selection, revision [84](#)
- Speedometer [14](#)
- "Sport"
 - "EDC" [92](#)
- Stability control, refer to Driving stability control [89](#)
- Standing lamps [97](#)
- Start/stop button [61](#)
- Starting [62](#)
- Starting assistance [187](#)
- Starting problems [62](#), [188](#)
- Starting the engine [62](#)
- "State inspection" [79](#)
- Station
 - sample [143](#)
 - scan mode [144](#)
- Status lines in Control Center [24](#)
- Steering column
 - adjustment [53](#)
- Steering wheel [18](#)
 - individual button assignment options [53](#)
- Steering wheel adjustment, automatic [53](#)
- Steering wheel heater [53](#)
- Steering wheel memory [54](#)

Steptronic 69
Stopwatch 85
Storage, refer to Car care manual
Storage compartments 111
Storing preset speeds, refer to Programmable cruise control 75
Straps, refer to Loading 120
Summer tires 173
Sun blinds 109
Switch for battery 185
Switching air conditioner on and off 101
Switching off the engine 62
Switching off with mobile phone 162
Switching on
– audio 140
– cassette deck 153
– CD changer 149
– CD player 146
– MD player 151
– radio 140
Symbols 6
– Control Center 20
System failure reports, refer to Check Control 80

T

Tachometer 77
Tail lamps 183
– bulb replacement 183
"Tape" 140, 153
Technical modifications 8, 98
Telephone, refer to Mobile phone 158
Telephone directory
– creating voice command telephone directory 162
– dialing numbers 163
– updating voice command telephone directory 162
"Temp. distribution" 51
Temperature adjustment 101
Temperature display, outside temperature 77

Third brake lamp 183
Tilt function, passenger-side mirror 54
Time
– of arrival, estimated 83
Timing 85
Tire change 184
Tire inflation pressures 170
Tire pressure monitor 92
Tire Quality Grading 172
Tires
– flat tire 184
– tire changes 184
– tire damage 171
– tire inflation pressures 170
– tire pressure monitoring system 92
– tire replacement 172
– tire size, refer to Wheel and tire combinations 173
– tire tread 171
– tire tread wear indicators 171
Title search
– cassette deck 154
Tone in audio operation
– adjusting 141
"Tone" in sound system operation 141
Tools 181
"TOP 8" 163
Torque 192
Tow fittings 188
Towing 188
Track 193
Traction Control System, refer to DSC 89
Traffic congestion, refer to Selecting new route 133
Transmission
– automatic transmission with L mode 66
– automatic transmission with Steptronic 69
Transmission lockout 67, 70
– manual release 70
Travel route, see Route 132
Tread depth, tires 171

"Treble" in sound system operation 141
Trip odometer 77
Trunk lid
– emergency release 40
– refer to luggage compartment lid 38
Turning circle 193
Turn signal indicators 71
– bulb replacement 182, 183

U

Undercoating, refer to Car care manual
Uniform Tire Quality Grading (UTQR) 172
Universal garage door opener 108
Upholstery care, refer to Car Care
Used batteries 186
User controls 16
"Using motorway" 130

V

Vacuum cleaner connection 113
Valve caps 185
Vanity mirror 53
Vehicle battery 185
Vehicle dimensions 193
Vehicle keys 34
Vehicle stability control 89
Ventilation 102
Ventilation, draft-free 102
Ventilation while parked 106
Vents, ventilation 99
"View" with navigation system 132, 133
Viscosity 177
Voice command system 18, 25
Voice command system notebook 27

Volume
– audio [141](#)
– navigation [133](#)
– voice command
system [141](#)

X

Xenon lamps [182](#)

W

Warning lamps [15](#)
Warnings [80](#)
Warning triangle [187](#)
Washing the vehicle, refer
to separate Car care
manual
"WB" [140](#)
WB [145](#)
Wear indicators in the
tires [171](#)
Weather Band [145](#)
Weights [194](#)
Wheel and tire
combinations [173](#)
Wheelbase [193](#)
Wheels and tires [173](#)
Width [193](#)
Windows [42](#)
– convenience mode [37](#)
– safety switch [43](#)
Windshield defroster, see
Defrosting windows [101](#)
Windshield washers [73](#)
Windshield wiper [71](#), [72](#)
Windshield wiper intermit-
tent mode, refer to Rain
sensor [71](#)
Windshield wiper
system [72](#)
Winter tires [173](#)
– setting speed limit [84](#)
Wiper blade
replacement [181](#)
Wiper system [71](#)
"With map" for
navigation [128](#), [129](#)
Wordmatch principle with
navigation system [136](#)
Working in the engine
compartment [175](#)

Refueling

To ensure that you always have all the essential data at hand when refueling, we recommend that you fill in the following tables with the specifications and information that apply to your vehicle. Consult the index for individual specifications.

Fuel

Designation

Please enter your preferred fuel here.

Tire inflation pressures

	Summer tires Front	Rear	Winter tires Front	Rear
Up to 4 persons				
5 persons or 4 plus luggage				

Engine oil

Quality

The distance between the two graduations on the dipstick represents an oil quantity of approximately 1.1 US quarts (1 liter).

More about BMW

www.bmw.com



The Ultimate
Driving Machine

